

# RECIRCULATING AND ENERGY-RECOVERING LINACS

Jean Delayen

Thomas Jefferson National Accelerator Facility  
Old Dominion University

# Recirculating Linacs

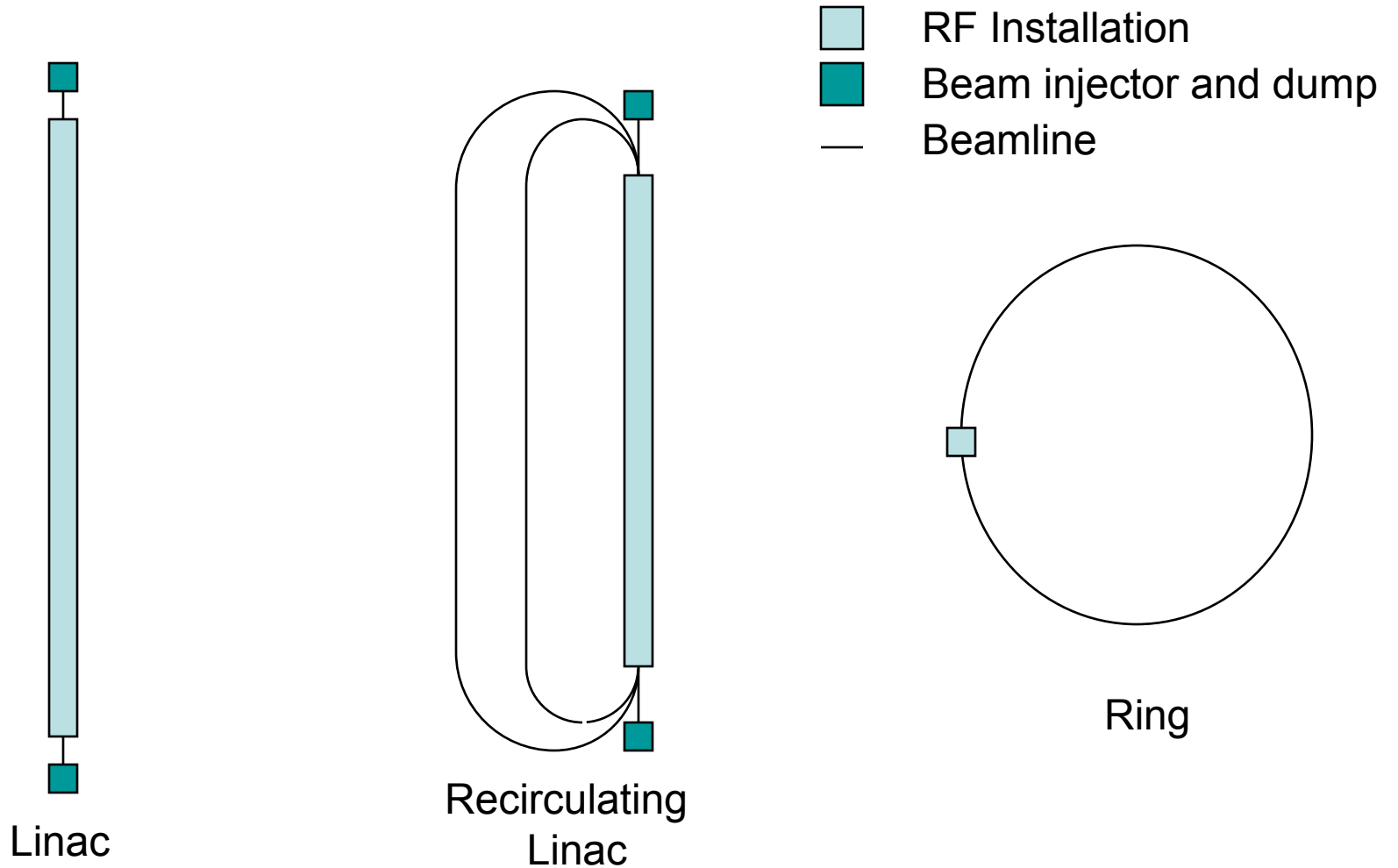

# Why Recirculate?

---

- Performance upgrade of an installed linac  
HEPL SCA doubled their energy this way
- Cheaper design to get a given performance  
Microtrons, by many passes, reuse expensive RF many times to get energy up.  
Penalty is that the average current has to be reduced (proportional to  $1/\text{number passes}$  for the same installed RF).  
CEBAF type machines: add passes until the “decremental” gain in RF system and operating costs pays for additional recirculating loop.  
Jefferson Lab FEL and other Energy Recovered Linacs (ERLs) save the cost of higher average power RF equipment (and much higher operating costs) at higher CW operating currents by “reusing” the beam energy through beam recirculation.

# Features of Recirculating Linacs and Storage Rings

---

## Linacs

- Emittance dominated by source emittance and emittance growth down linac
- Beam Polarization “easily” produced at the source, switched, and preserved
- Total transit time is quite short
- Beam is easily extracted.
- Utilizing source control, flexible bunch patterns possible
- Long undulators are a natural addition
- Bunch durations can be SMALL

## Storage Rings

- Up to now, the stored average current is much larger
- Very efficient use of accelerating voltage
- Technology well developed and mature (+ or -)
- There’s nothing you can do about synchrotron radiation damping

# Challenges for Beam Recirculation

---

- **Additional Linac Instability**
  - **Multipass Beam Breakup (BBU)**
  - **Observed first at Illinois Superconducting Microtron**
  - **Limits the average current at a given installation**
  - **Made better by damping HOMs in the cavities**
  - **Best we can tell at CEBAF, threshold current is around 20 mA, similar in the FEL**
  - **Changes based on beam recirculation optics**
- **Turn around optics tends to be a bit different than in storage rings or more conventional linacs. Longitudinal beam dynamics gets coupled strongly to the transverse dynamics.**
- **HOM cooling will perhaps limit the average current in such devices.**

# The CEBAF at Jefferson Lab

- Most radical innovations (had not been done before on the scale of CEBAF):
  - choice of srf technology
  - use of multipass beam recirculation
- Until LEP II came into operation, CEBAF was the world's largest implementation of srf technology.



# CEBAF Accelerator Layout

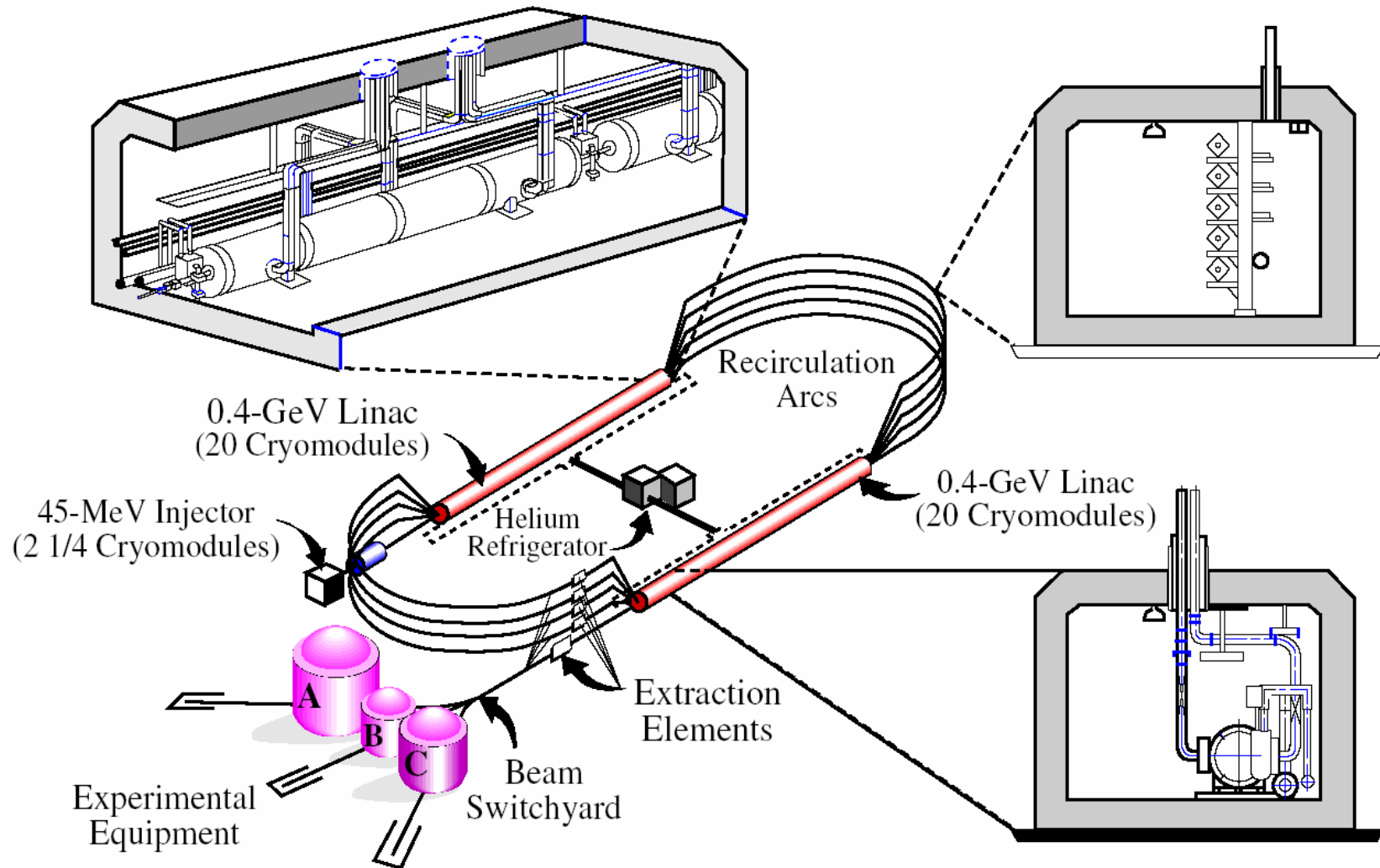

# 6 GeV CEBAF Accelerator Layout

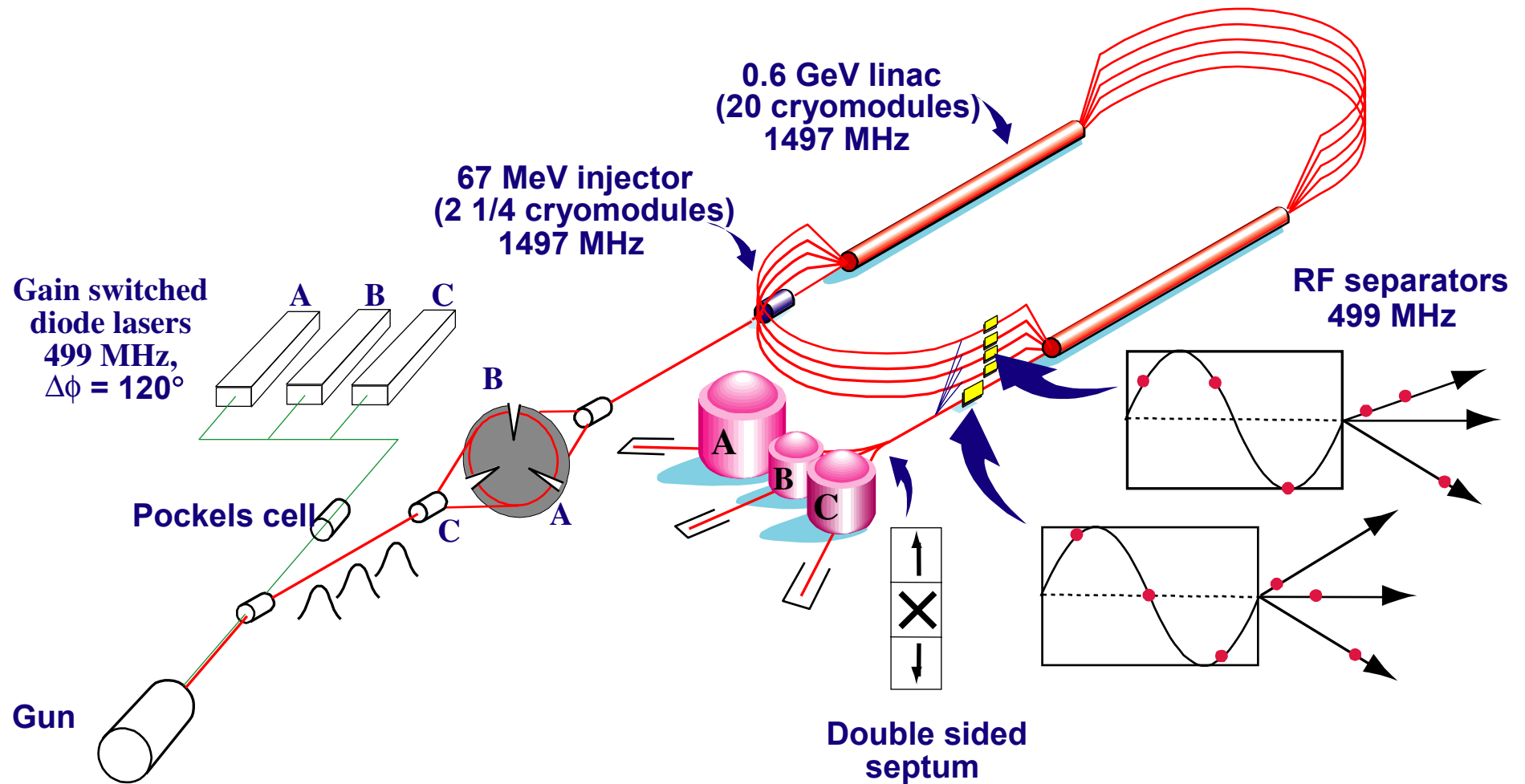



# CEBAF Beam Parameters

---

Beam energy	6 GeV
Beam current	A: 100 $\mu$ A, B: 10-200 nA, C: 100 $\mu$ A
Normalized rms emittance	1 mm mrad
Repetition rate	500 MHz/Hall
Charge per bunch	< 0.2 pC
Extracted energy spread	< 10
Beam sizes (transverse)	< 100 microns
Beam size (longitudinal)	100 microns (330 fsec)
Beam angle spread	< 0.1/ $\gamma$

# CEBAF Accelerator

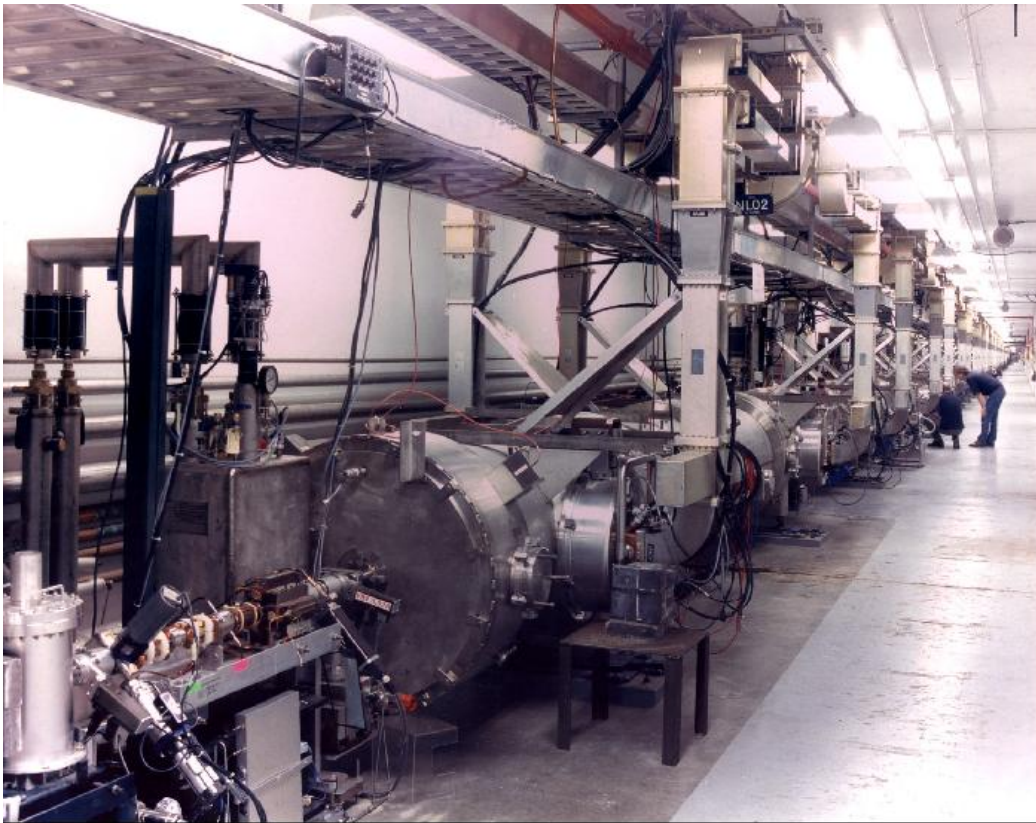

# CEBAF Cavities





# SRF Parameters for Upgrade

---

- **What is needed?**
    - **Present:**            **6 GeV / 5 passes = 1.2 GeV/pass = 0.6 GeV/linac**
    - **12 GeV:**            **12 GeV / 5.5 passes = 2.2 GeV/pass = 1.1 GeV/linac**
- ⇒                            **Need to add 0.5 GV/linac**

Adding 0.5 GV/linac

- There are 5 empty zones at the end of each linac
- 12 GeV Can be achieved with a 100 MV cryomodule in each new zone.

Present cryomodules operate at 30 MV on average.

# 100 MV Cryomodules - Gradient

- Simplest change would be to add more cells.
  - Present 8.5m-long cryomodules have 4.0m of active length.
  - 7-cell cavities would use 5.6m - OK
  - Gives 40% more voltage with the same gradient.

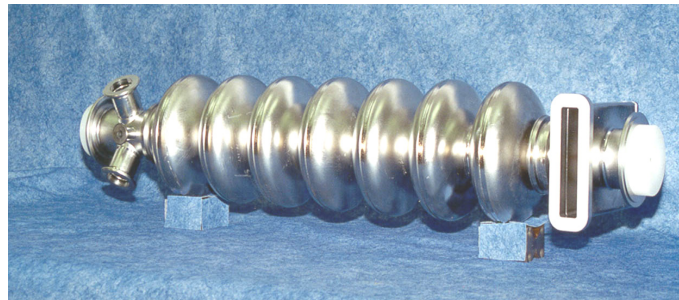

Prototype  
7-cell cavity

- 40% helps but is not enough -- Need more gradient

How much gradient is needed?

- 100 MV / 5.6 m = 17.5 MV/m
  - Add 10% for cavities that might be off-line
- } 19.2 MV/m

# 100 MV cryomodules - $Q_0$

---

- Will use one 5 kW cryo plant per linac
- Each plant must support:
  - Present needs of each linac
  - 5 new cryomodules (static and dynamic loads)
- 250 W available at 2.05K for each new cryomodule

19.2 MV/m cw  
250 W



$$Q_0 = 8 \times 10^9$$

# 100 MV Cryomodule RF Power requirements

- **Beam power per cavity: 6.8 kW at 21 MV/m**
- **Actual  $Q_{\text{external}}$  is 70% of optimum (use stub tuners)**
- **25 Hz of detuning**
  - 4 Hz (2x the tuner resolution of 2 Hz)
  - + 21 Hz (6x the standard deviation of the existing cavities' noise spectrum)
- **Need gain. ∴ Don't run the klystron into saturation.**

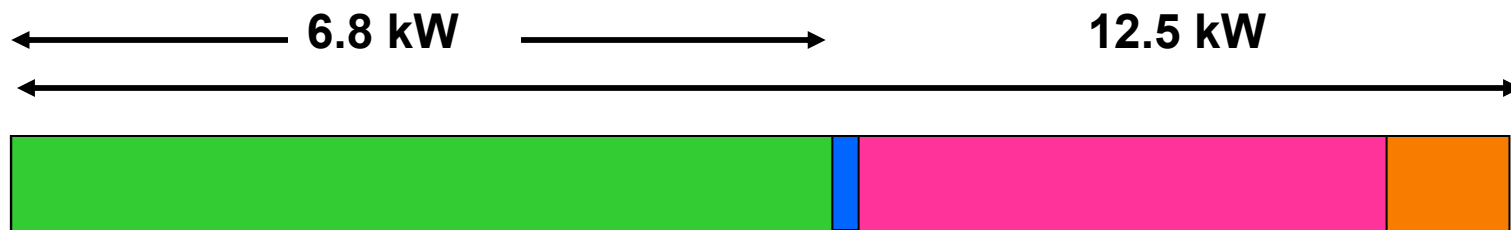

**13 kW klystrons**



# Completed Cavity String First Upgrade Prototype Cryomodule (80MV)



# Energy Recovery Linacs

---

- **Energy recovery is the process by which the energy invested in accelerating a beam is returned to the rf cavities by decelerating the same beam**
- **There have been several energy recovery experiments to date**
  - **Stanford SCA/FEL**
  - **Los Alamos FEL**
  - **CEBAF front end**
- **Same-cell energy recovery with cw beam current up to 5 mA and energy up to 50 MeV has been demonstrated at the Jefferson Lab IR FEL. Energy recovery is used routinely for the operation of the FEL as a user facility**

# The CEBAF Injector Energy Recovery Experiment

N. R. Sereno, "Experimental Studies of Multipass Beam Breakup and Energy Recovery using the CEBAF Injector Linac," Ph.D. Thesis, University of Illinois (1994)

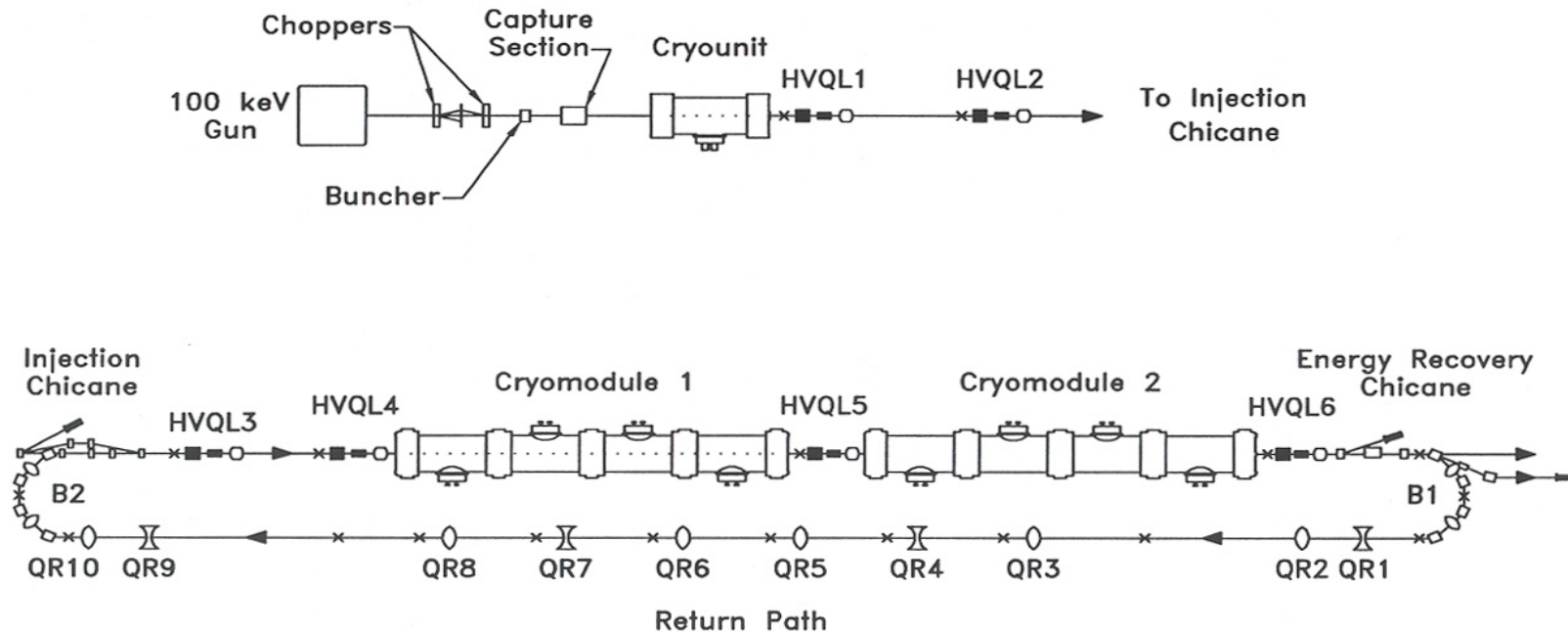

# ERL/FEL Light Source

## Energy Recovery and its Potential

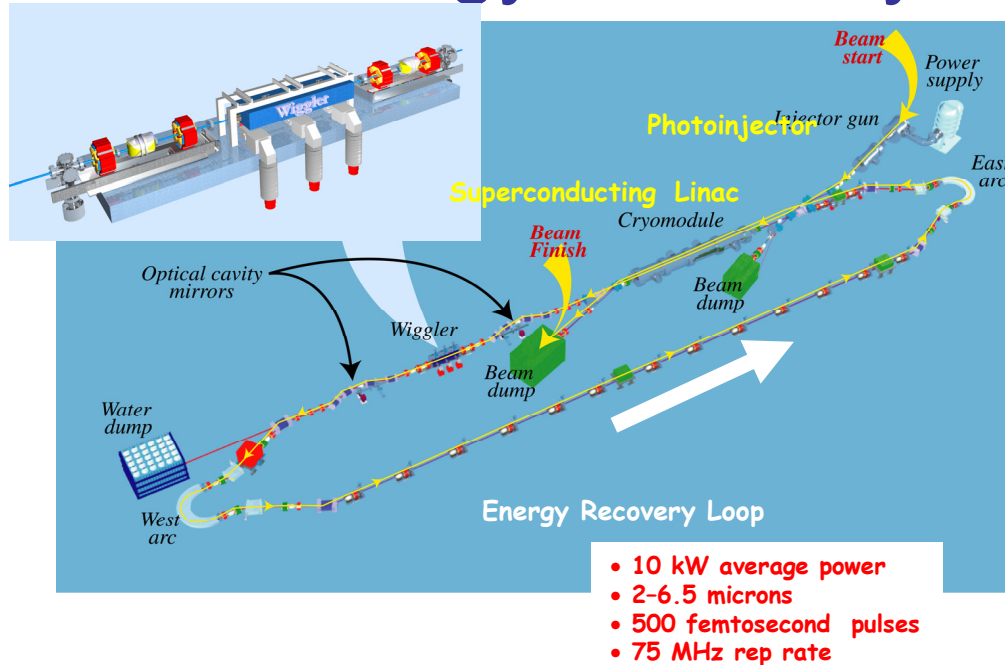

*JLab ERL-based  
Free Electron Laser*

- 10 kW average power
- 2-6.5 microns
- 500 femtosecond pulses
- 75 MHz rep rate

*First high current energy recovery  
experiment at JLab FEL, 2000*

RF Power Draw in Energy Recovery

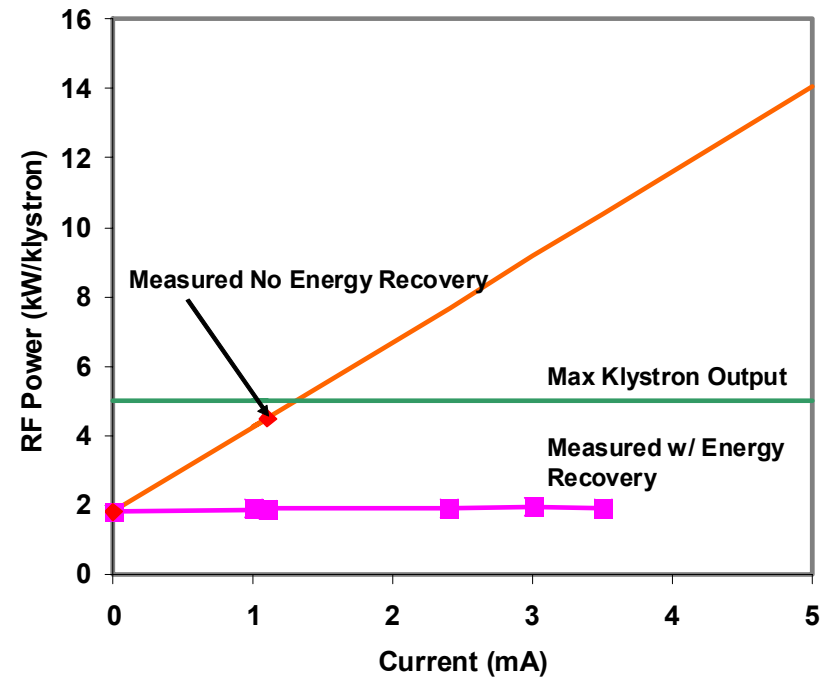

# 100 MeV ERL

## >10 kW IR and 1 kW UV

### JLab FEL/ERL Upgrade

### JLab FEL Upgrade

- THz User Labs
- Attosecond Beam
- UV User Labs
- IR User Labs

1 MW class electron beam, (100 MeV x 10mA), comparable to beam power in CEBAF accelerator (1 GeV x 1mA), but supported only by klystrons capable of accelerating 10-100 kW electron beam.

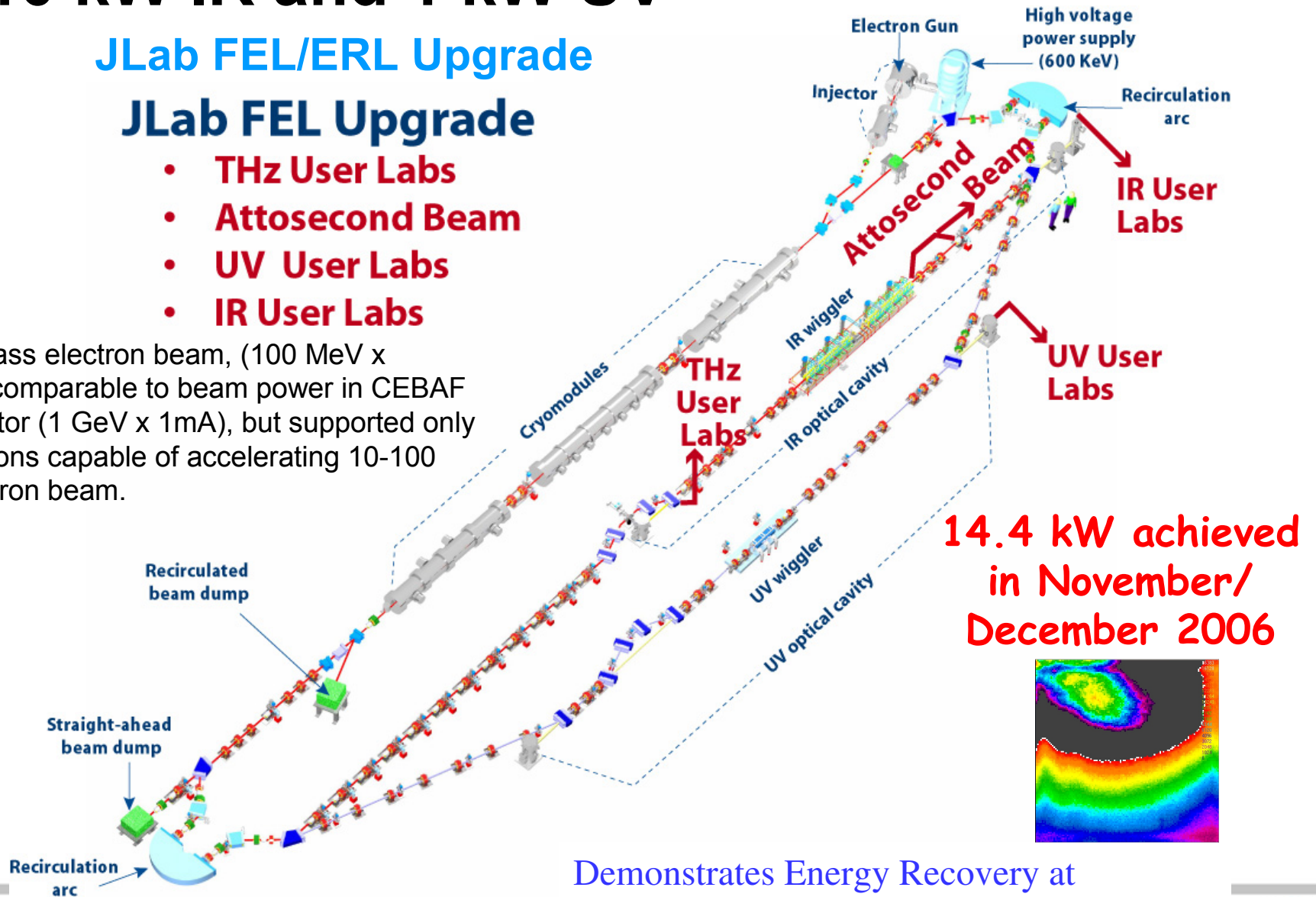

**14.4 kW achieved  
in November/  
December 2006**

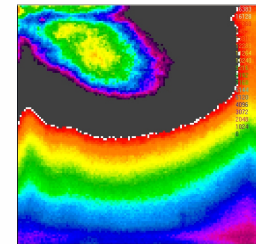

Demonstrates Energy Recovery at moderate current levels of 10 mA CW.

# State of the Art in ERL Technology

## JLab IR FEL Upgrade

Achieved 14.2 kW CW IR power on October 30, 2006!

Energy recovered up to 9.1 mA at 150 MeV

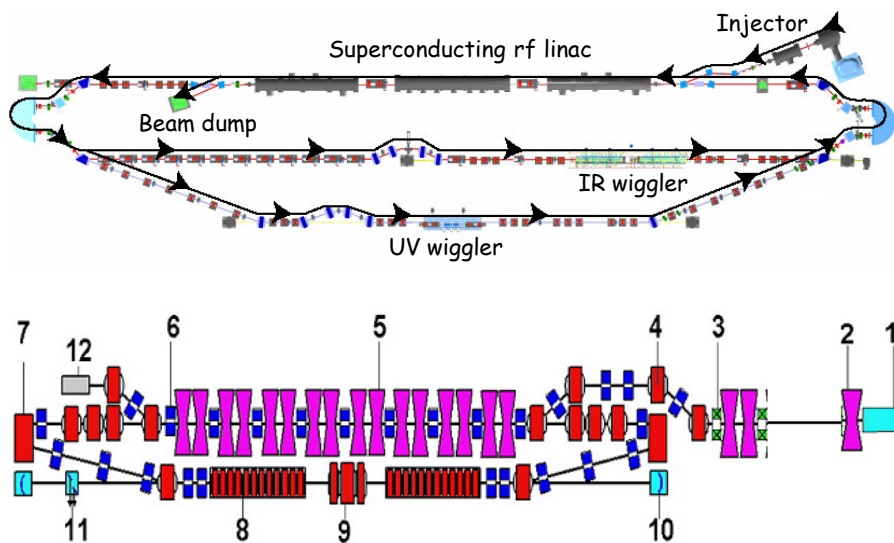

JLab IR FEL Electron Beam Parameters	Design	Achieved
Energy (MeV)	145	160
Bunch charge (pC)	135	150
Average current (mA)	10	9.1
Bunch length* (fs)	400	150
Norm. emittance* (mm-mrad)	30	7
Max. Bunch rep. rate (MHz)	74.85	74.85

\*Quantities are rms

## Novosibirsk High Power THz FEL

Energy recovered highest average current to date:

20 mA at 1.7 nC per bunch using 180 MHz NC RF

# ERL Light Sources

## FEL ERLs

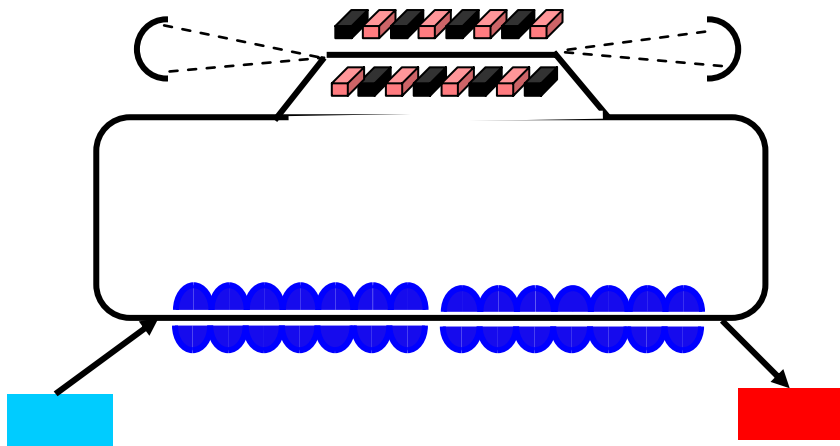

### Requirements

Energy ~ 120 MeV

Charge ~ 0.1 - 1 nC/bunch

Emittance ~ 5-10 mm-mrad

Average current ~ 100 mA

## Synchrotron Light ERLs

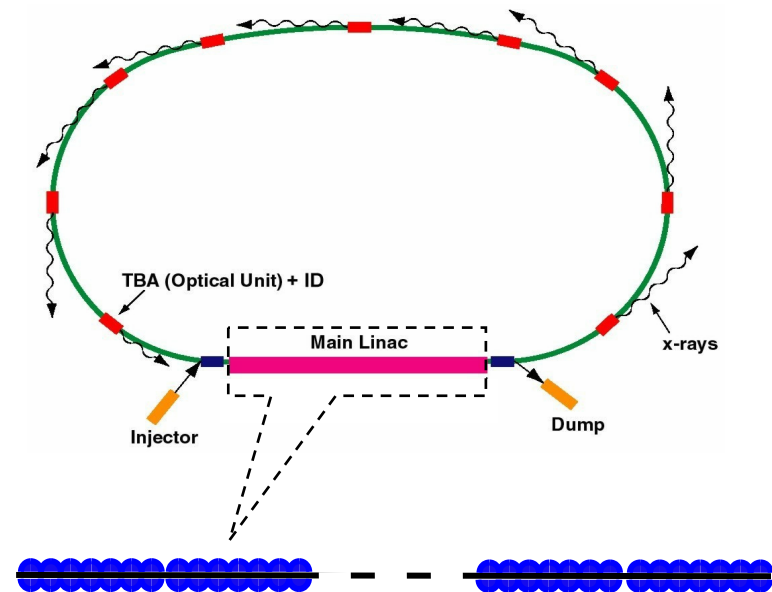

### Requirements

Energy ~ 1 GeV

Charge ~ 0.1 nC/bunch

Emittance ~ 0.1 mm-mrad

Average current ~ 100 mA

# ERLs for Nuclear and Particle Physics

## Electron Cooling of hadron storage rings

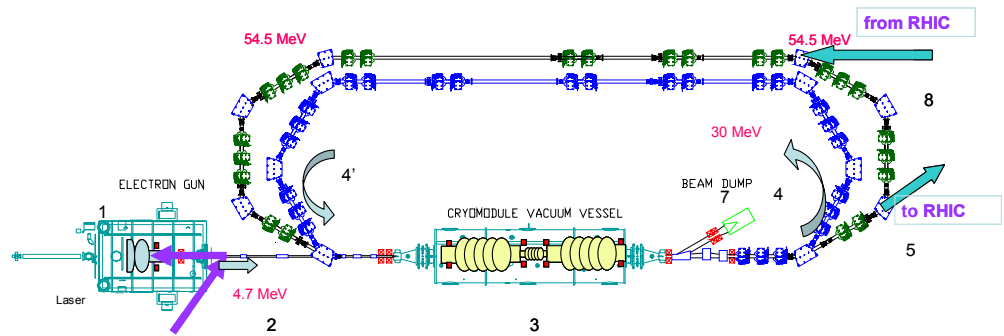

## Provide electron beams for high-luminosity electron-ion colliders

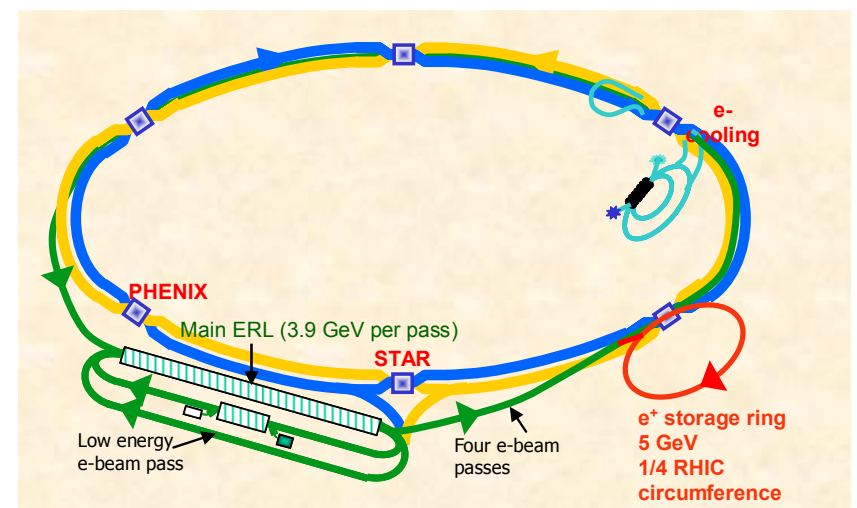

### Requirements

- Energy ~ 50 MeV
- Charge ~ 5 nC/bunch
- Emittance ~ 3 mm-mrad
- Average current ~ 50-100 mA

### Requirements

- Energy ~ 10-20 GeV
- Charge ~ 10-20 nC/bunch
- Emittance ~ 20 mm-mrad
- Average current ~ 250 mA
- Polarization ~ 80%



# Demonstration of Energy Recovery

Gradient modulator drive signal in a linac cavity measured without energy recovery (signal level around 2 V) and with energy recovery (signal level around 0).

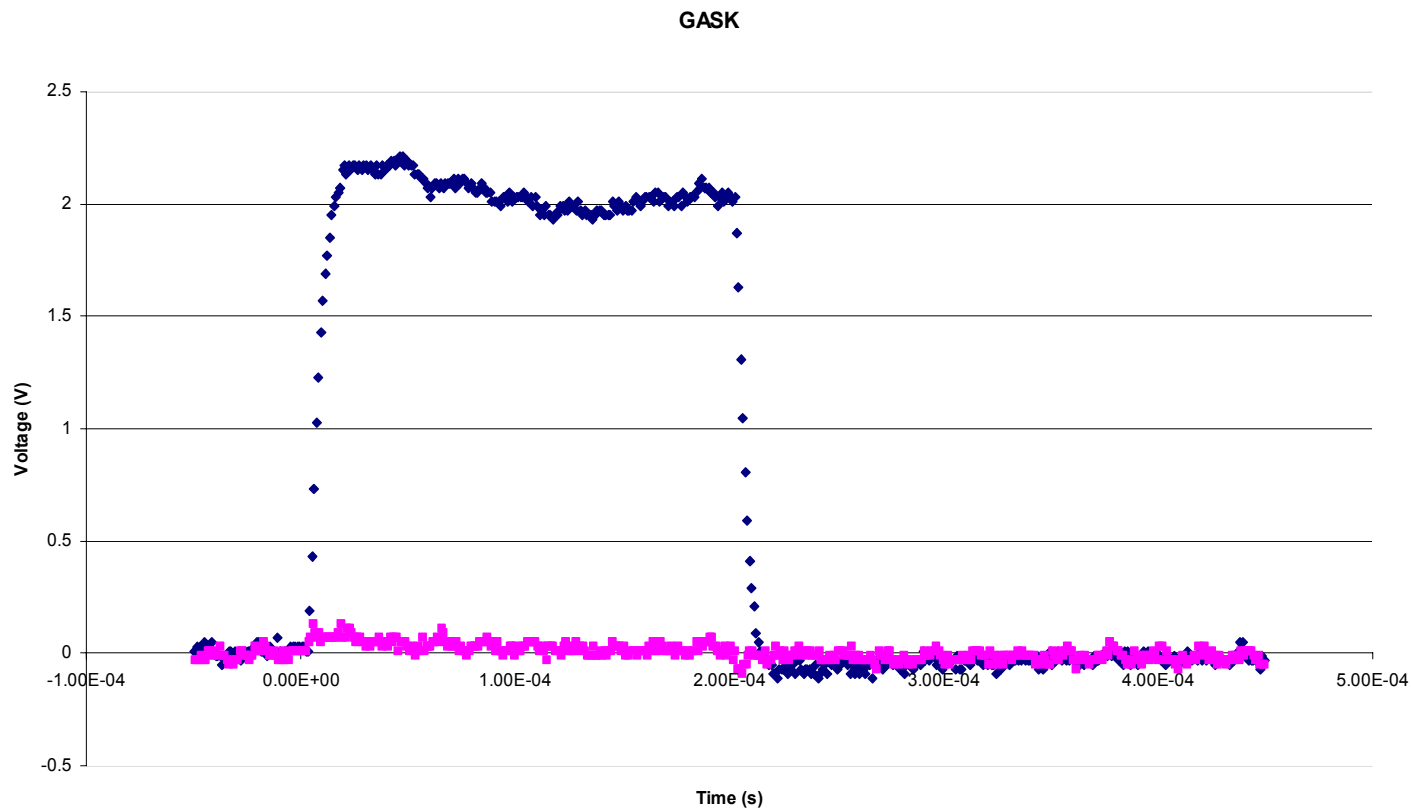

# Demonstration of Energy Recovery

With energy recovery the required linac rf power is  $\sim 16$  kW, nearly independent of beam current. It rises to  $\sim 36$  kW with no recovery at 1.1 mA

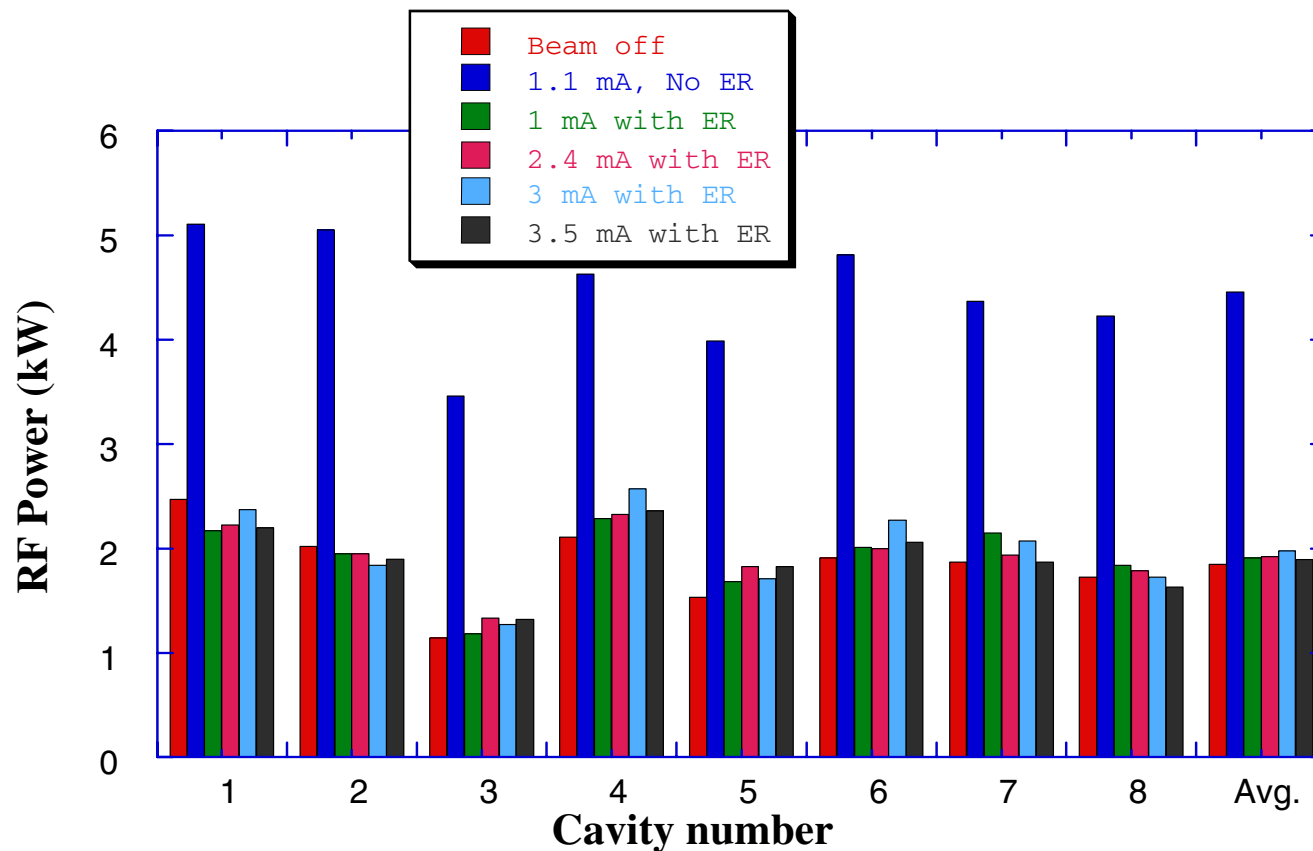

# Demonstration of High Energy ERL

## High Energy Demonstration of Energy Recovery

- Beam accelerated from **45 MeV** to **1 GeV** and energy recovered to 45 MeV.
- Inject at **10 to 20 MeV** and test energy recovery with energy ratio up to  $\sim 100$
- Beam properties, beam halo measured at several locations
- Experiment was performed in March-April 2003

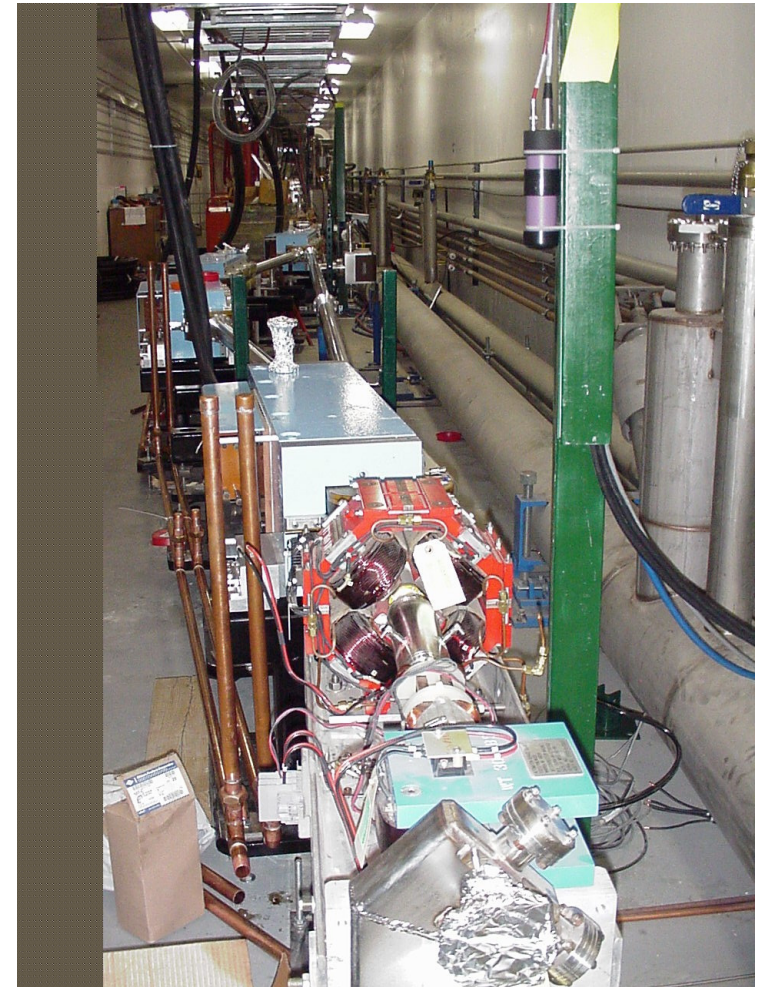
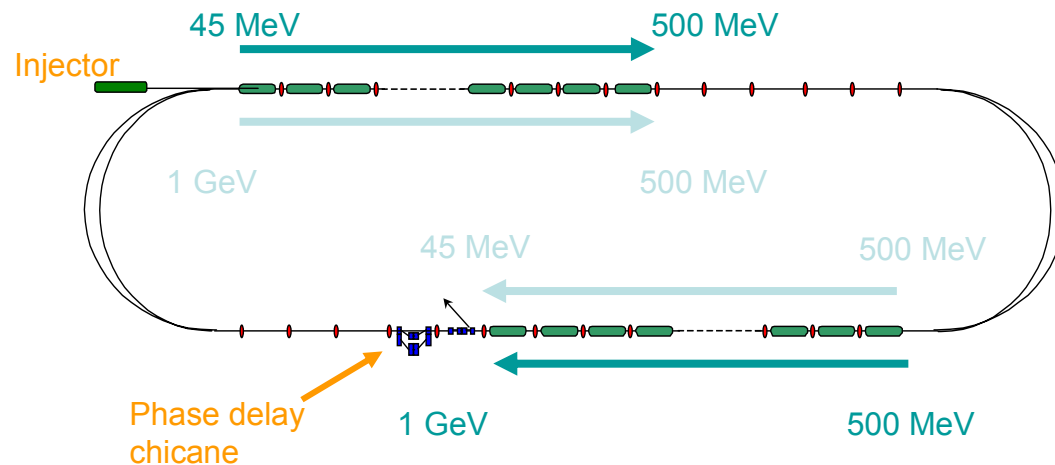

CEBAF-ER Installation

# First Energy Recovery Experiment at High Energy at CEBAF, April 2003; Second Phase planned in 2008

Beam profiles at end (SL16) of South Linac

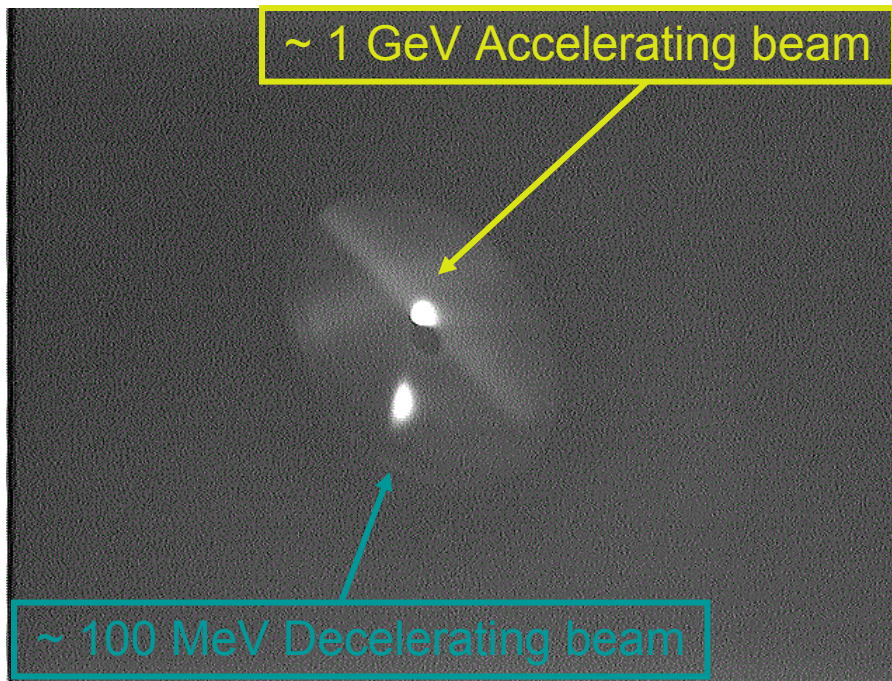

Energy Ratio of up to 1:50 tested at CEBAF (20 MeV  $\leftrightarrow$  1 GeV)

Gradient modulator drive signals with and without energy recovery in response to 250  $\mu$ sec beam pulse entering the rf cavity

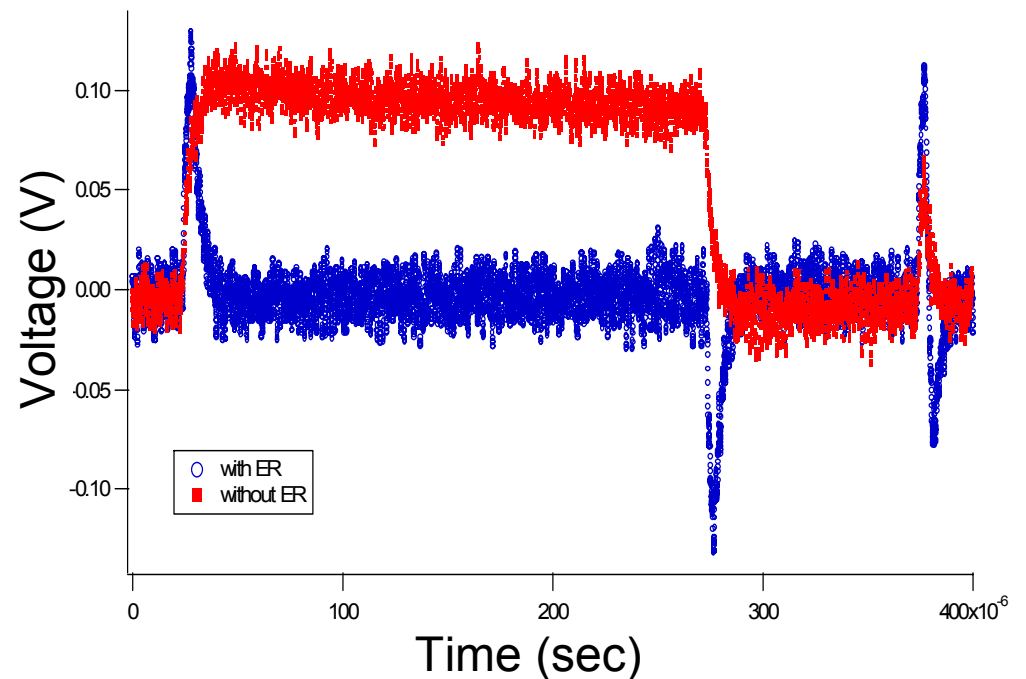

# Features of Energy Recovery

---

- **With the exception of the injector, the required rf power is nearly independent of beam current**
  - **Increased overall system efficiency**
  - **Reduced rf capital cost**
- **The electron beam power to be disposed of at beam dumps is reduced by ratio of  $E_{\max}/E_{\text{inj}}$** 
  - **Thermal design of beam dumps is simplified**
  - **If the beam is dumped below the neutron production threshold, then the induced radioactivity (shielding problem) will be reduced**

# RF to Beam Multiplication Factor for an Ideal ERL

---

$$J = \frac{P_b}{P_g} = \frac{\text{Power absorbed by accelerated beam}}{\text{Generator power needed to create and control rf fields}}$$

$$J = \frac{\frac{VI}{V_c^2}}{2\left(\frac{R}{Q}\right)Q_L} = \frac{2I\left(\frac{R}{lQ}\right)Q_L}{2\left(\frac{R}{Q}\right)Q_L}$$

$$K = \frac{\text{Accelerated beam power}}{\text{Installed rf power}}$$

$$K = \frac{JE_f}{(J-1)E_{inj} + E_f}$$

# RF to Beam Multiplication Factor for an Ideal ERL

$$E_{acc} = 20 \text{ MV} / m$$

$$R / lQ = 1000 \Omega / m$$

$$E_{inj} = 10 \text{ MeV}$$

$$E_f = 7 \text{ GeV}$$

## RF to Beam Multiplication Factor

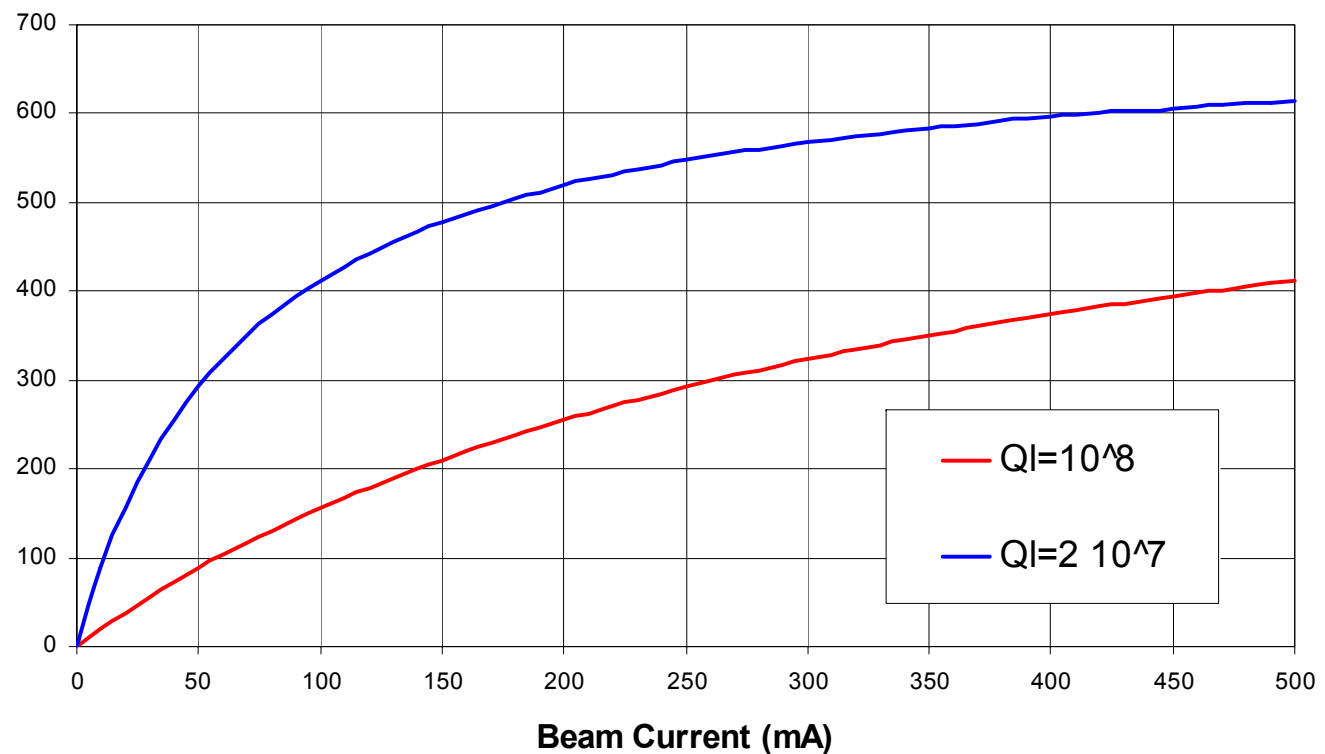

# RF to Beam Multiplication Factor for an Ideal ERL

---

- The efficiency of an ERL (as measured by the rf to beam multiplication factor) increases with current
  - Asymptotic value is  $E_{\text{max}}/E_{\text{inj}}$
- The efficiency increases with the loaded Q of the energy-recovering cavities



# User Requirements and Beam Properties

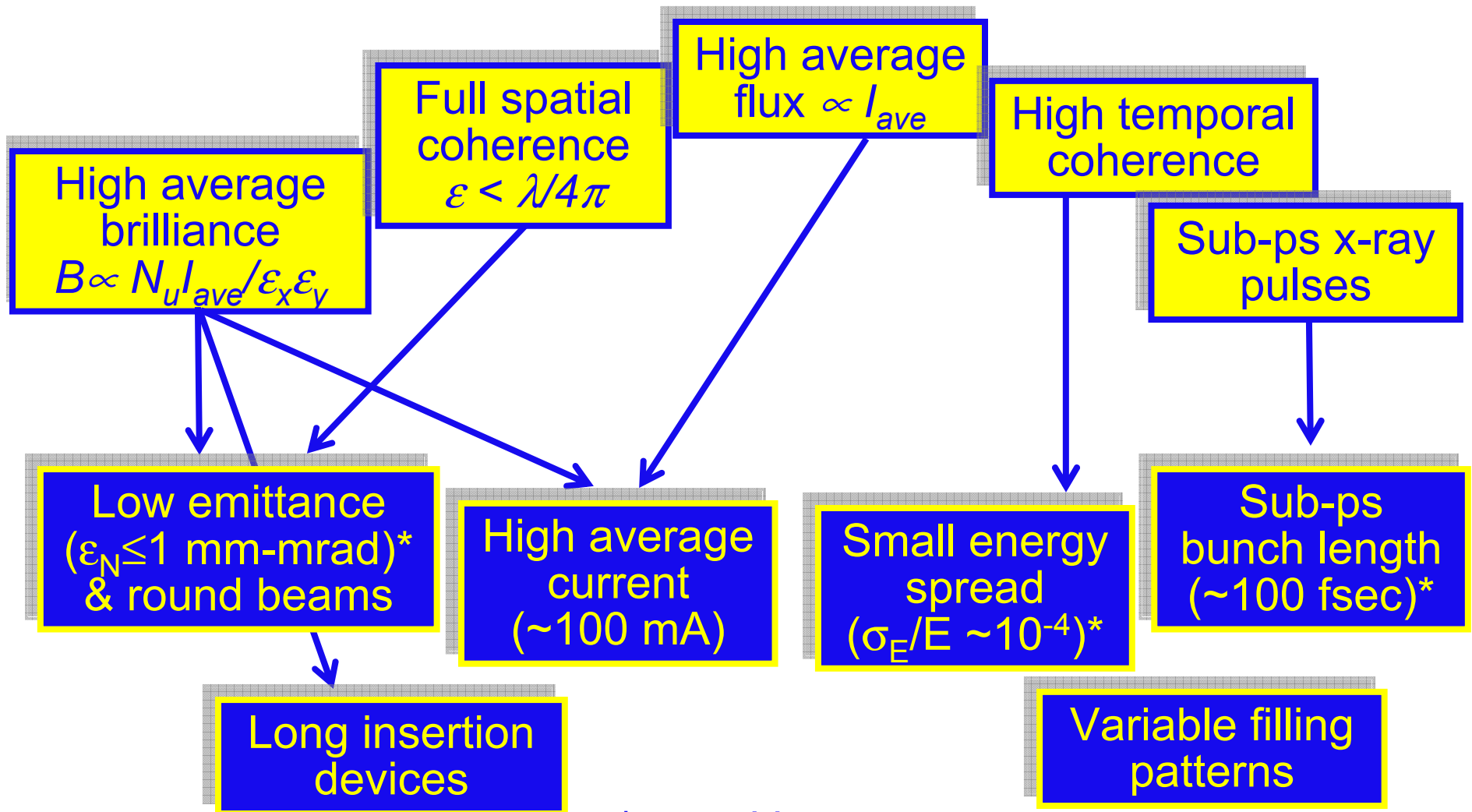

\*quantities are rms

# Accelerator Physics & Technology Issues of ERLs

---

- **Accelerator Transport**
  - **Longitudinal Matching**
  - **Transverse Matching**
  - **Beam Loss**
- **CSR**
- **RF Control in ERLs (High  $Q_1$ )**
- **Collective Effects**
  - **Single-bunch Effects**
  - **Multipass, Multibunch Beam Breakup (BB.U) Instabilities**
- **HOM Power Dissipation**
- **Beam Loss**
- **Photocathode Longevity**
- **High  $Q_0$**

# Three Main Challenges

---

- Generation and preservation of low emittance, high average current beams
- Accelerator transport
- High current effects in superconducting rf

# Challenge I: Generation and Preservation of Low Emittance, High Average Current Beams

---

*In an ERL, highest quality beam must be produced at the source, and preserved in the low-energy regime*

Ia. High accelerating gradients or high repetition rate? Or both?

Ib. Getting beyond the space charge limit

# DC Photoinjectors under construction/testing

---

- **Cornell:**  
500 – 750 kV, 1.3 GHz, 100 mA
- **JLab/AES:**  
500 kV, 750 MHz, 100 mA
- **Daresbury ERLP:**  
Duplicate of JLab FEL gun, 6.5 mA
- **JAEA:**  
250 kV, 50 mA gun, superlattice photocathode

# RF photoinjectors

- To date RF guns have produced best normalized emittances:  
 $\epsilon_{N,rms} \sim 1 \mu\text{m}$  at  $q \sim 0.1 - 1 \text{ nC}$  , but at relatively low rep rate (10-100 Hz)
- **Challenge:** Balance high gradient (low emittance) with high rep rate (thermal effects)

## State-of-the-art: Boeing gun

- Repetition rate 433 MHz at 25% DF
- Average current 32 mA

## Planned RF Photoinjectors

- **LANL/AES:** 700 MHz, 100 mA

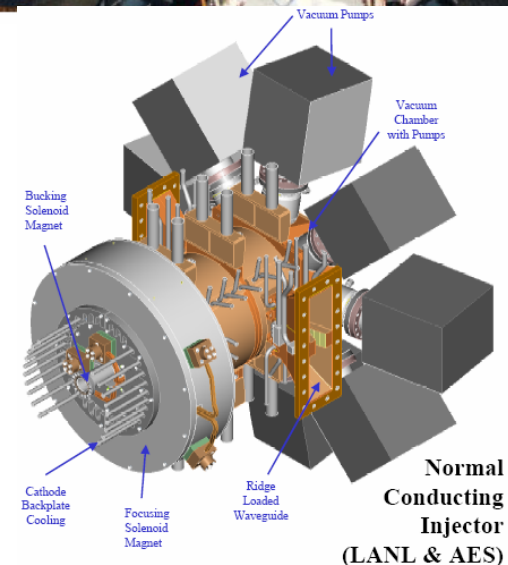
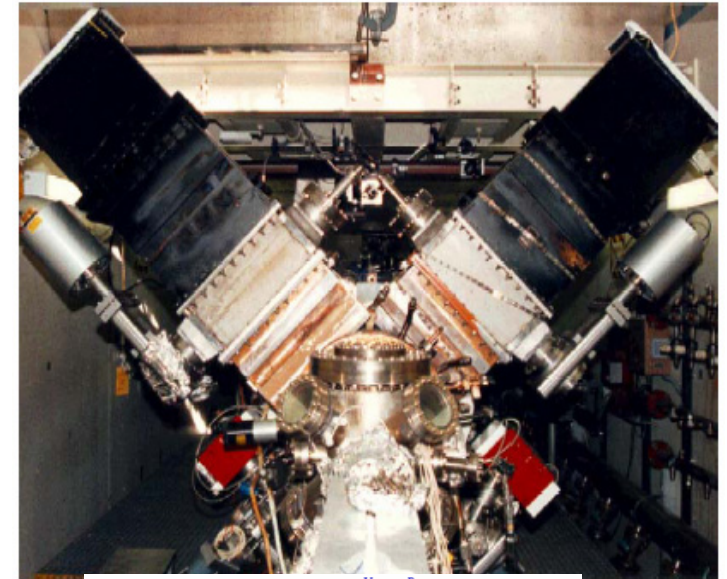

# SRF photoinjectors

---

- High CW RF fields possible
- Significant R&D required
- Two major developments in progress:
  - Rossendorf 3  $\frac{1}{2}$ -cell Nb cavity
  - BNL/AES  $\frac{1}{2}$ -cell Nb cavity with diamond amplified photocathode

# The Rossendorf SRF gun

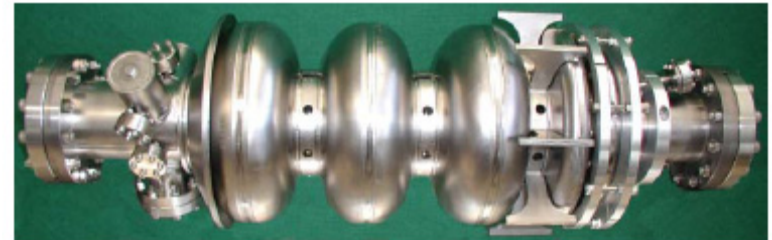
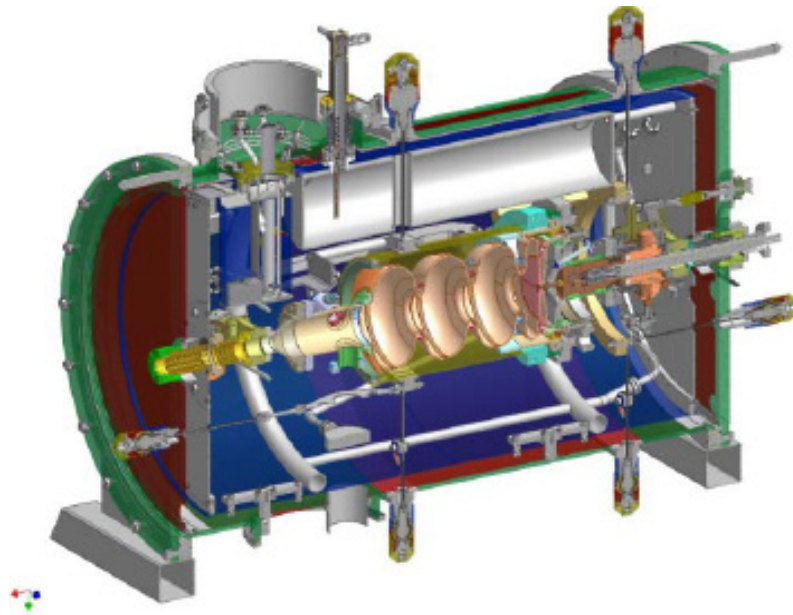

1.3 GHz, 9.5 MeV, CW operation  
 3 modes of operation:  
 - 77 pC at 13 MHz  
 - 1 nC up to 1 MHz (1 mA)  
 - 2.5 nC at 1 kHz

	ELBE mode	high charge mode	BESSY-FEL
RF frequency	1.3 GHz		
beam energy	9.5 MeV		
operation	CW		
drive laser	262 nm		
photocathode	Cs <sub>2</sub> Te		
quantum efficiency	~1 %		~2.5 %
average current	1 mA		2.5 μA
pulse length	5 ps	20 ps	50 ps
repetition rate	13 MHz	~1 MHz	1 kHz
bunch charge	77 pC	1 nC	2.5 nC
transverse emittance	1.5 μm	2.5 μm	3.0 μm



# BNL/AES Ampere-class SRF gun

## Diamond amplified photocathode

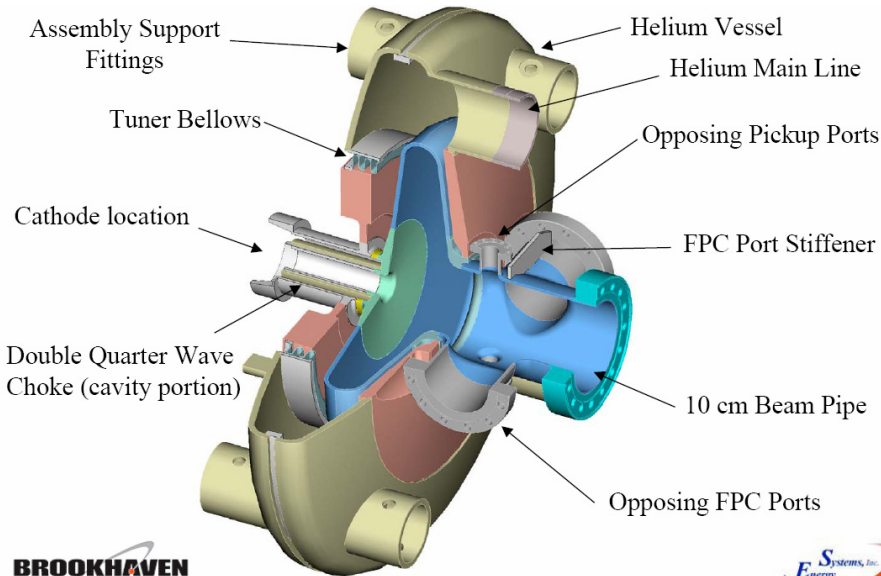

BROOKHAVEN  
NATIONAL LABORATORY

E Systems, Inc.  
Energy  
Advanced

703.75 MHz, 2.5 MeV, 500 mA,  
CW operation

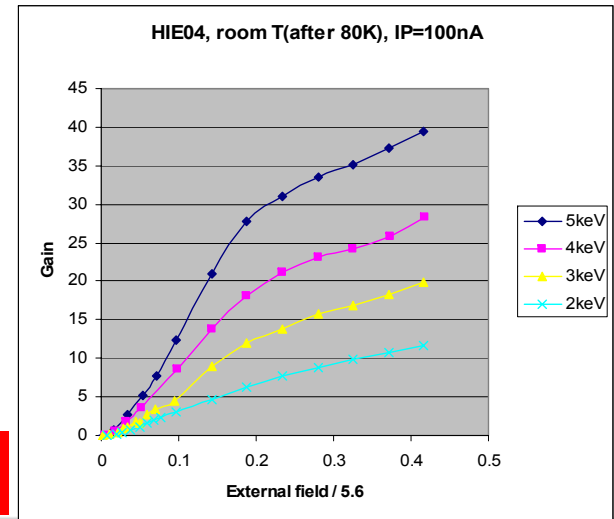
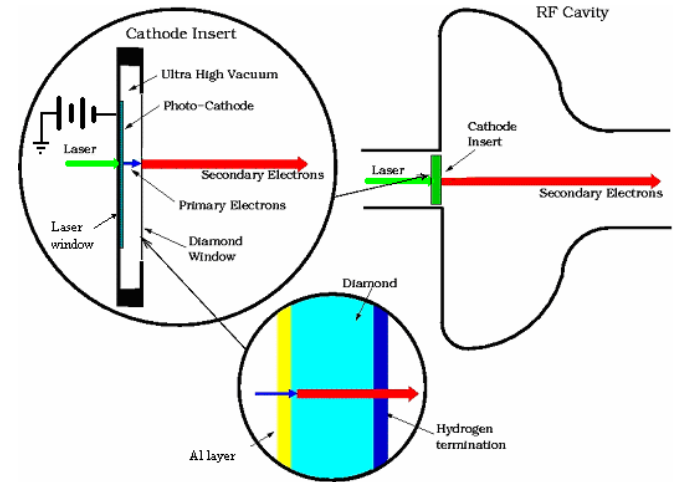

Courtesy: I. Ben-Zvi

# Challenge II: Accelerator Transport

---

*6-D emittance preservation and phase space management during acceleration and energy recovery*

**Ila. Wakefield effects (resistive wall)**

**Ilb. Halo and beam loss**

**Ilc. Beam stability and diagnostics**

# Power Loss due to Resistive Wall

## Wiggler chamber heating

- Observed drift in optical diagnostics traced to beam-induced heating of wiggler chamber.
- Temperature rise depends both on current and bunch length; 3.5 mA CW beam, 150 fs rms bunch length generated  $\sim 200$  W deposited on wiggler vacuum chamber.
- Observations consistent with resistive wall wakefield effects.
- The combination of short bunch length and high average intensity beams present new challenges in future ERLs.

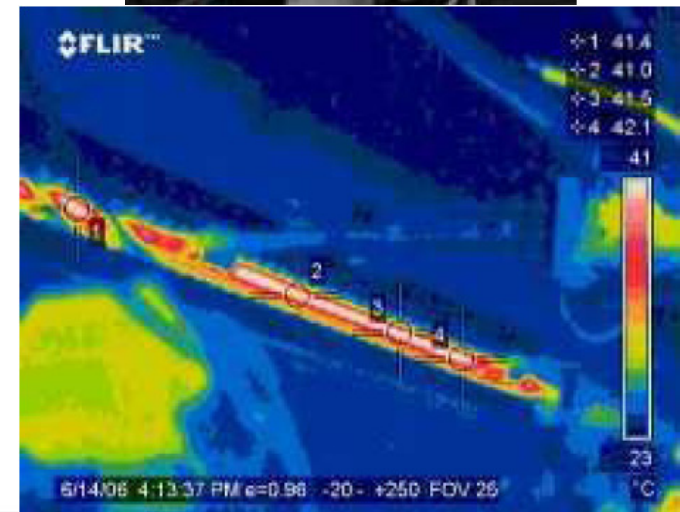

# Halo and Beam Loss

Beam loss an issue due to:

- direct damage to equipment
- unacceptable increase in vacuum pressure
- cryogenic load in the linac
- radiation damage to equipment

Courtesy: S. Benson,  
D. Douglas, G. Neil

Beam loss may result from:

- Scraping of beam halo due to space charge, drive laser scattered light, field emission
- Optical mismatch in beam transport

Beam losses in the JLab FEL during ~10 mA operation:

- <1  $\mu\text{A}$  loss set by Beam Loss Monitoring system
- Actual losses <100 nA in worst locations, ~10 nA in most locations
- 10-20 nA at the wiggler

Presently managed by beam optical methods resulting in improvements by more than an order of magnitude.

In future 100 mA ERLs beam loss must be controlled to better than 1 PPM

- > Mitigation likely to also include collimation
- > Need for improved machine protection systems

# Beam Stability and Diagnostics

---

- Bunch-to-bunch variations in charge, position, angle will likely have to be controlled
- Measurements at CEBAF:
  - Orbit stability  $\sim 2\text{-}4\ \mu\text{m}$  (with implementation of feedback)
  - Energy stability  $\sim 1 \times 10^{-4}$  (with implementation of feedback)
  - Energy spread stability  $\sim 2 \times 10^{-5}$  (continuously monitored in CW mode during machine operations)
- Unique to ERLs is the need to diagnose and control short bunches, the need to deal with tune up modes, and the high average beam power.
- Diagnostics development in the areas of:
  - Real-time, non-invasive techniques that will allow continuous monitoring of transverse and longitudinal beam properties
  - Synchronization systems
  - Improved machine protection systems
- Much interesting work is needed on this topic.

# Challenge III: High Current Effects in Superconducting RF

---

*Beam stability and beam quality preservation, and cryogenic efficiency during acceleration/deceleration of high average current, short bunch length beams in SRF environment*

**IIIa. Efficient extraction of HOM power**

**IIIb. Stability against multipass beam breakup**

**IIIc. RF control and stability under max practical  $Q_L$**

# HOM Power Dissipation

---

- High average current, short bunch length beams in SRF cavities excite HOMs. On average, HOM power loss per cavity is:

$$P_{\text{HOM}} = 2 k_{\parallel} Q_{\text{bunch}} I_{\text{ave}}$$

and extends over high frequencies (~100 GHz).

## The challenge:

- Adequate damping of HOMs and extraction of HOM power with good cryogenic efficiency.

# Multipass Beam Breakup

---

- In recirculating linacs, multipass beam breakup (BBU), driven predominantly by high-Q superconducting cavities, can potentially limit the average current.
- The “feedback” system formed between beam and cavities is closed and instability can result at sufficiently high currents.
- Energy recovering linacs can support enough beam current to reach the threshold of the instability.



# Frequency Distribution of HOM Power

Monopole Mode Single Bunch Power Excitation per 9-Cell Cavity

$$\sigma_{\text{bunch}} = 0.7 \text{ mm}, q_{\text{bunch}} = 77 \text{ pC}$$
$$P_{\text{total}} = 185 \text{ W}$$

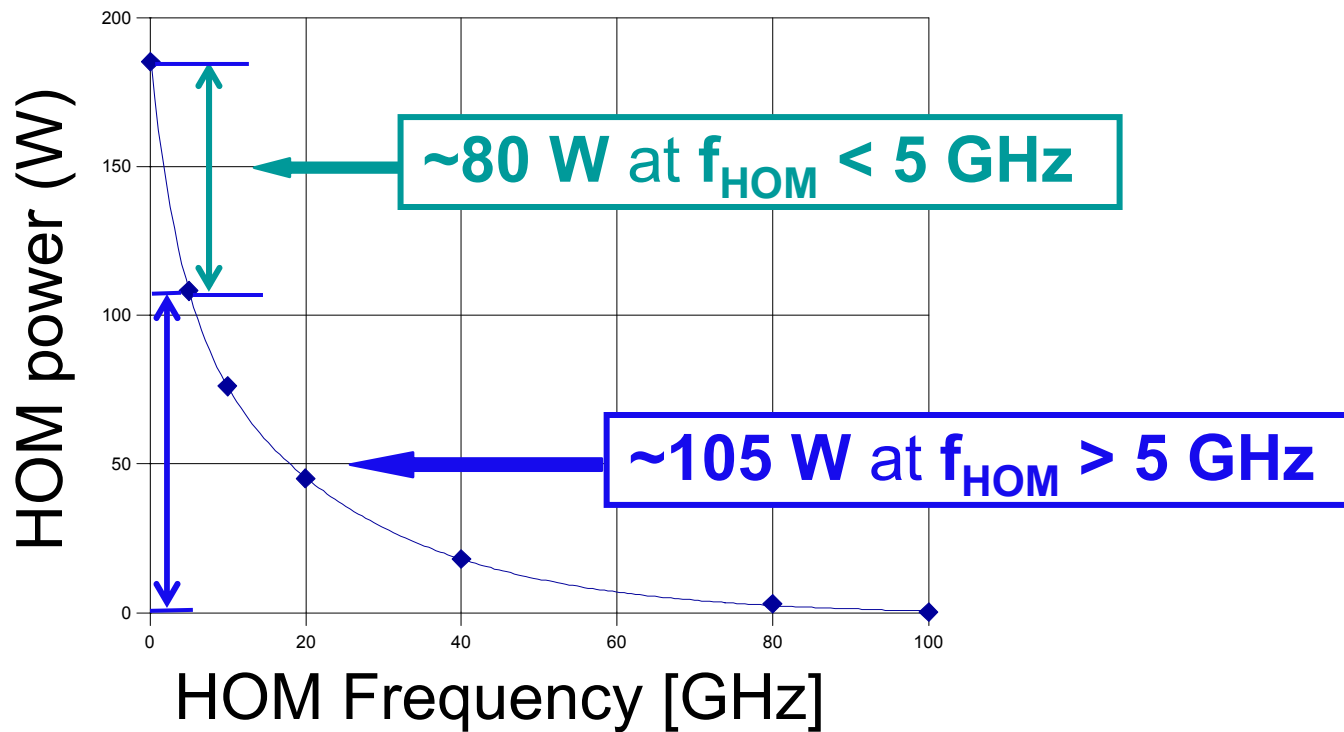

# HOM damping scheme for the Cornell ERL

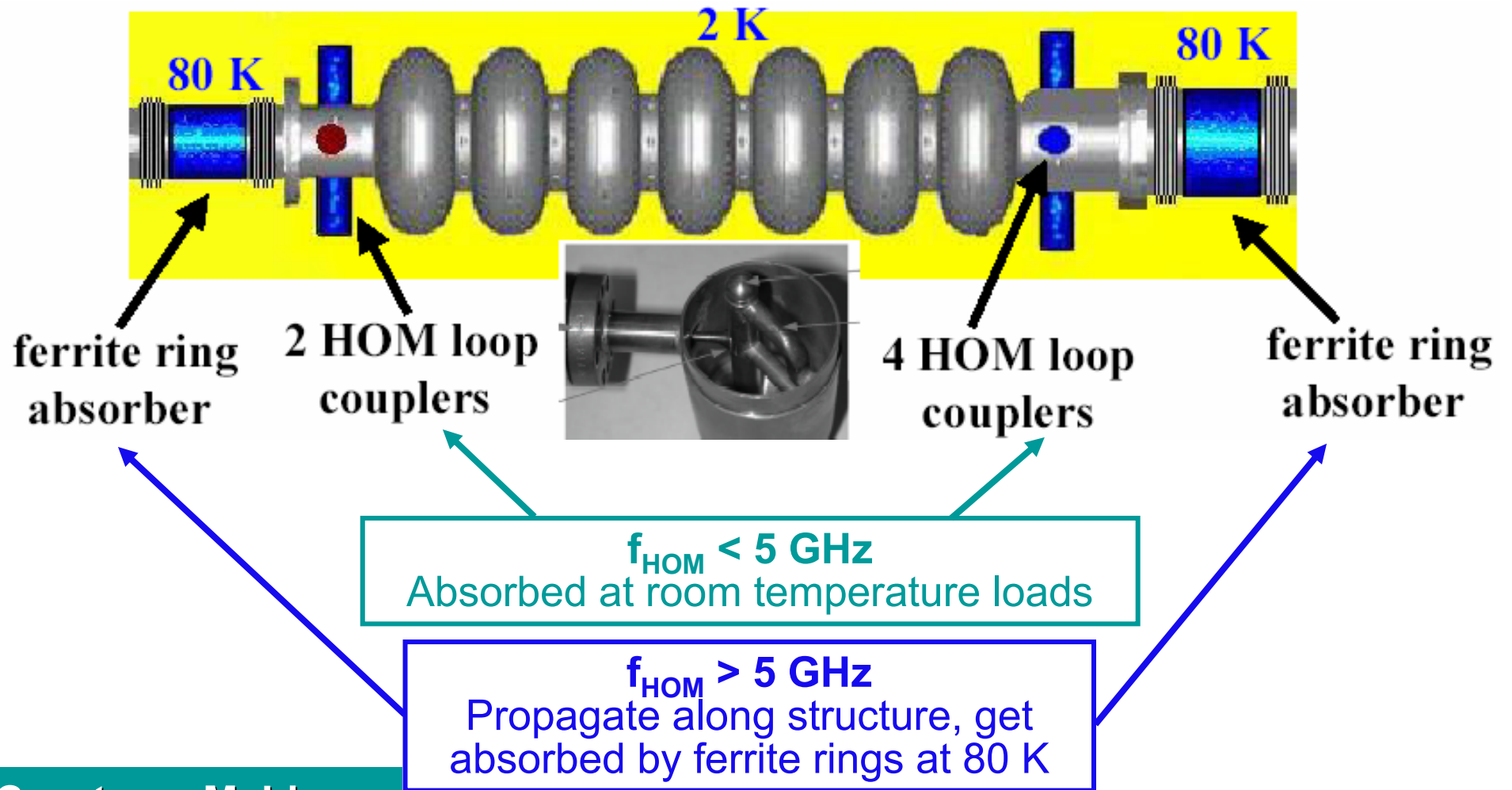

Courtesy: M. Liepe

# Frequency Distribution of HOM Power

Monopole Mode Single Bunch Power Excitation per 9-Cell Cavity

$$\sigma_{\text{bunch}} = 0.7 \text{ mm}, q_{\text{bunch}} = 77 \text{ pC}$$
$$P_{\text{total}} = 185 \text{ W}$$

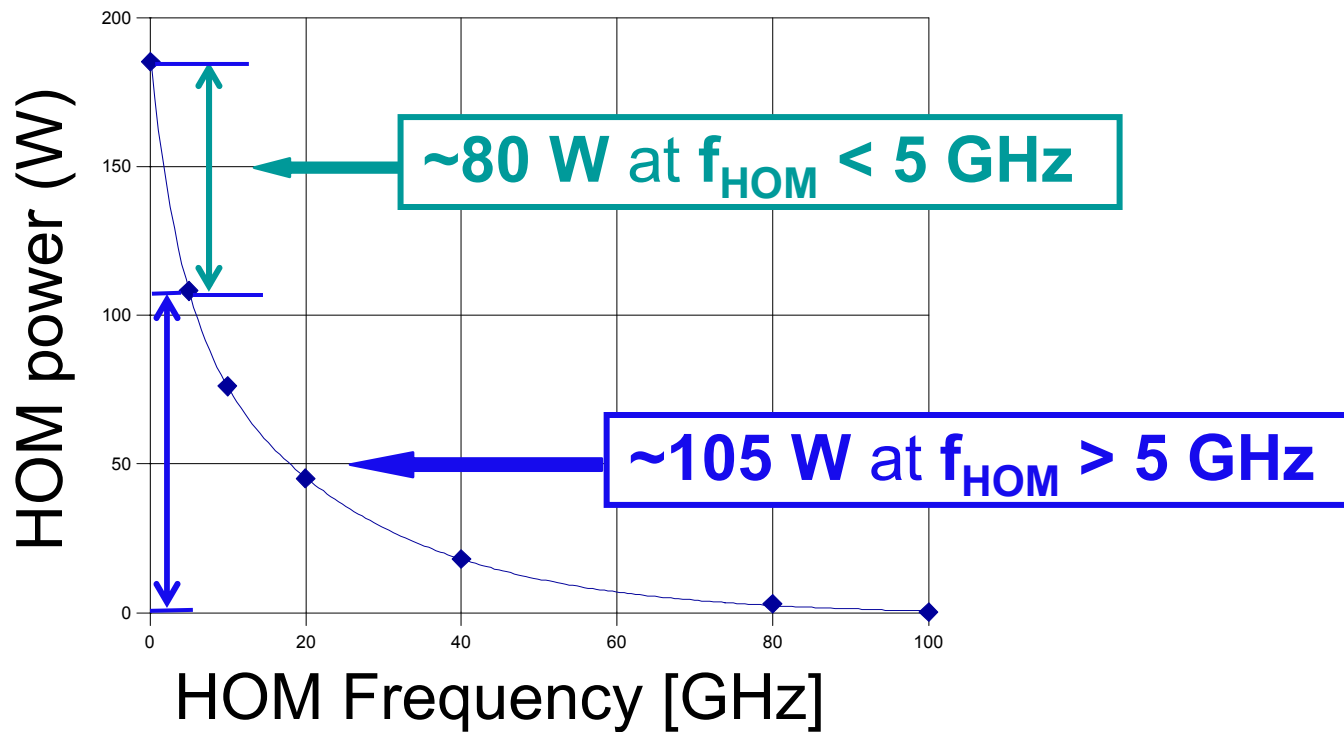

# Multipass Beam Breakup

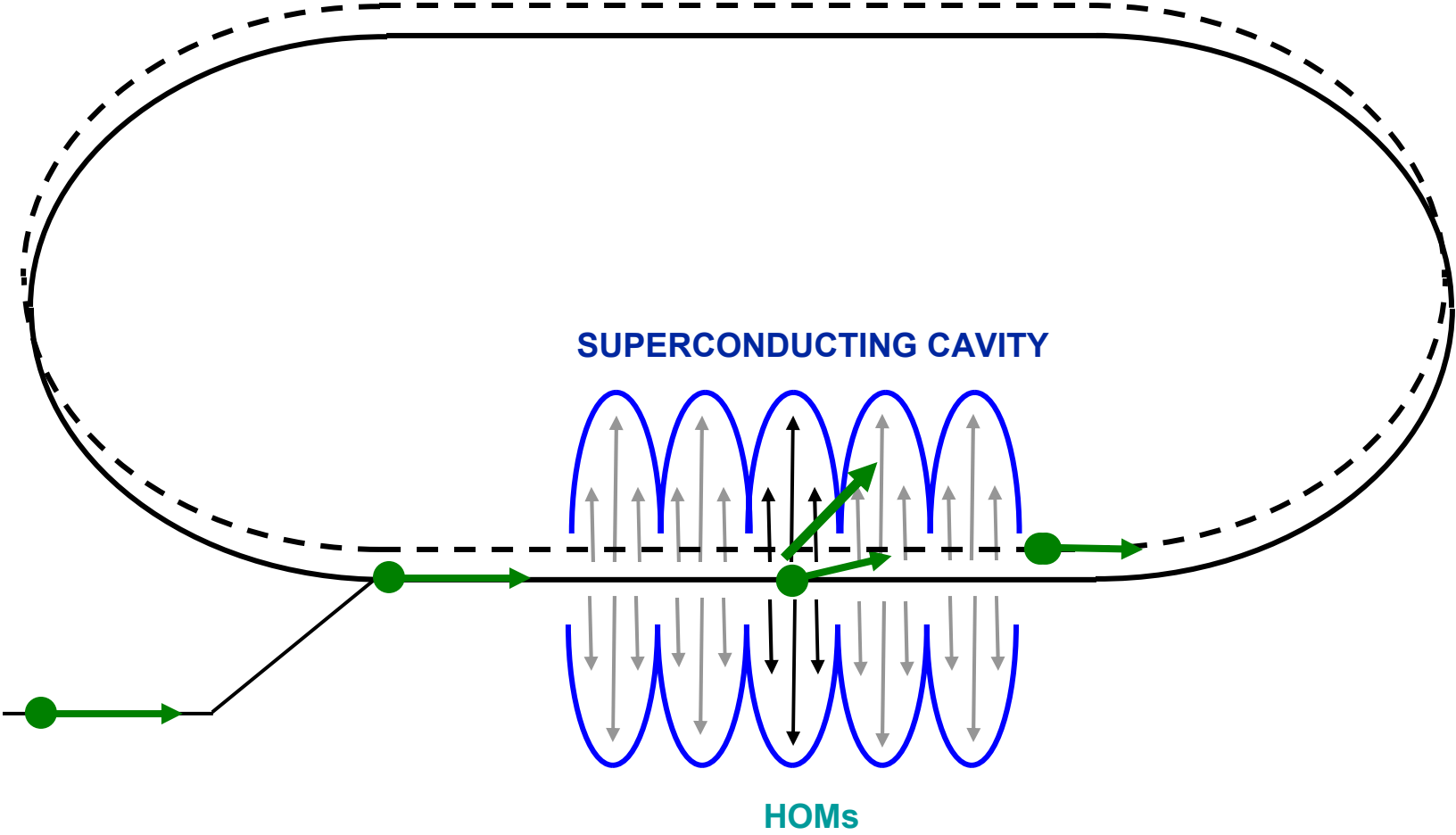

# Instability Threshold

- There is a well-defined threshold current that occurs when the power fed into the mode equals the mode power dissipation
- An analytic expression that applies to all instabilities:

$$I_{th}^{(1)} = \frac{-2 p_r c}{e(R/Q)_m Q_m k_m M_{ij} \sin(\omega_m t_r + l\pi/2) e^{\omega_m t_r / 2Q_m}}$$

- For  $i,j = 1,2$  or  $3,4$  and  $m \rightarrow \perp$  HOM  $\Rightarrow$  Transverse BBU
- For  $i,j = 5,6$  and  $m \rightarrow \parallel$  HOM  $\Rightarrow$  Longitudinal BBU
- For  $i,j = 5,6$  and  $m \rightarrow$  Fundamental mode  $\Rightarrow$  Beam-Loading Instabilities
- $l=1$  for longitudinal HOMs and  $l=0$  otherwise

# Suppressing Beam Breakup

Three methods:

## 1. Q-damping

Active Damping led to  $5x I_{th}$   
3-stub tuner led to  $1.5x I_{th}$

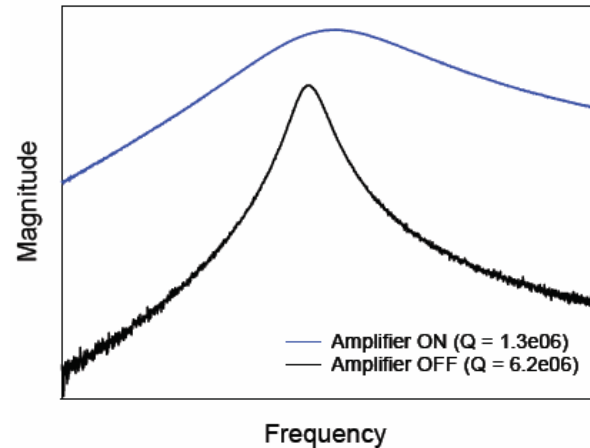

## 2. Beam optical schemes

“Phase trombone” *stabilized*

“Reflecting” or “Rotating” optics\* led to  $5x I_{th}$

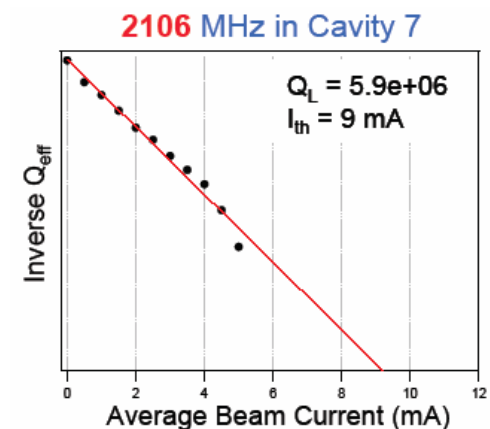
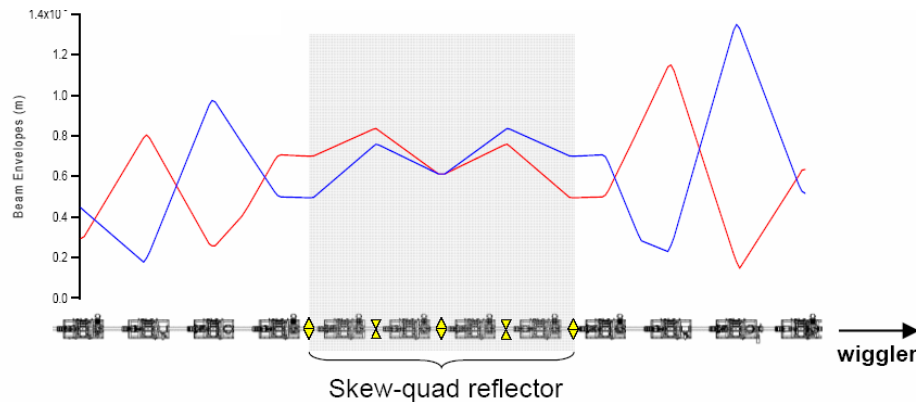

## 3. Beam-based feedback

\*R. Rand and T. Smith, Particle Accelerators 1980

# Lower Frequency SRF Development

Courtesy of I. Ben-Zvi

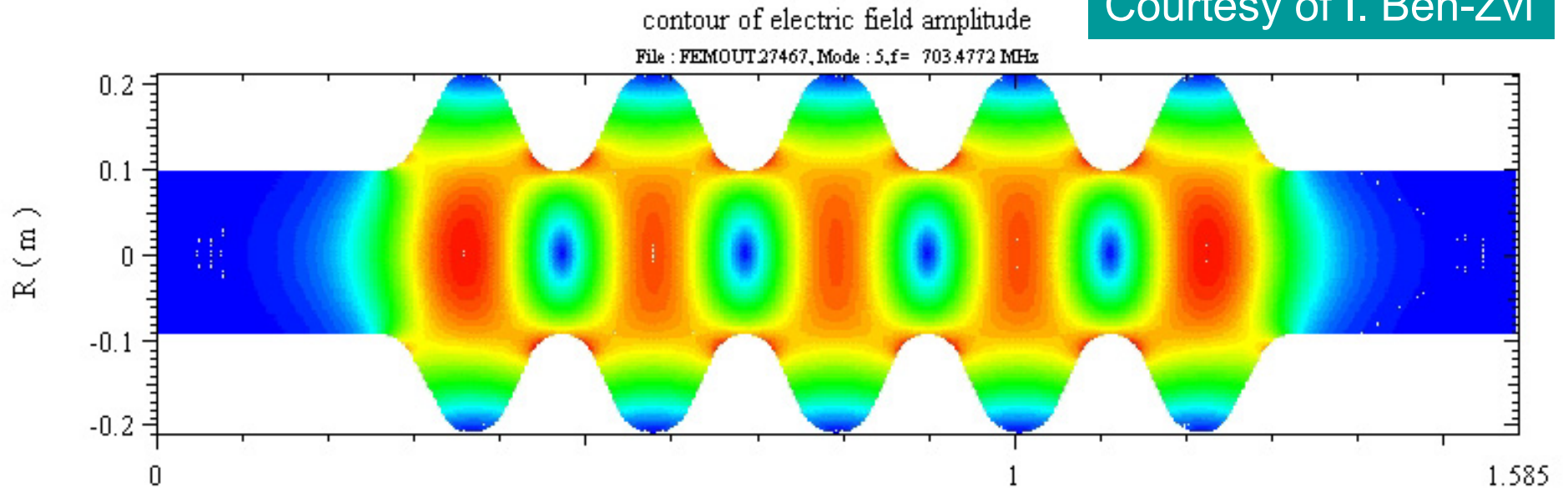

Develop CW SRF cavity for high intensity beams:  
Large bore, 700 MHz cavity with ferrite HOM dampers and high beam break-up threshold  
BNL-JLAB collaboration

**Predicted BBU threshold current > 1 Amp**

# BNL Ampere-class cavity

SRF ERL cavity for ampere-class current.



“Single mode”:  
All HOMs damped.  
  
Multi ampere rating.

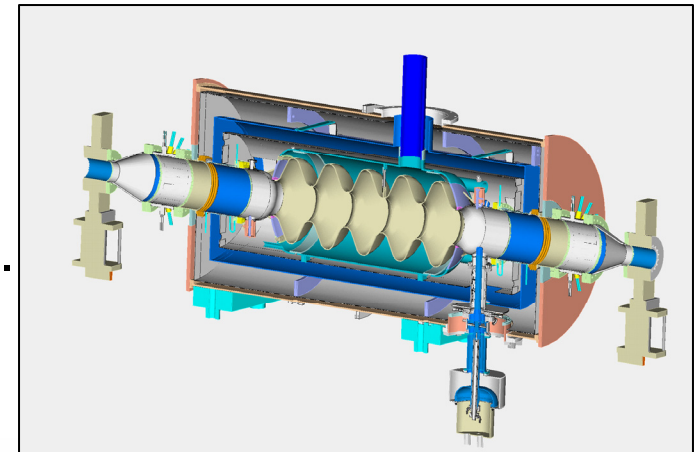

TDBBU

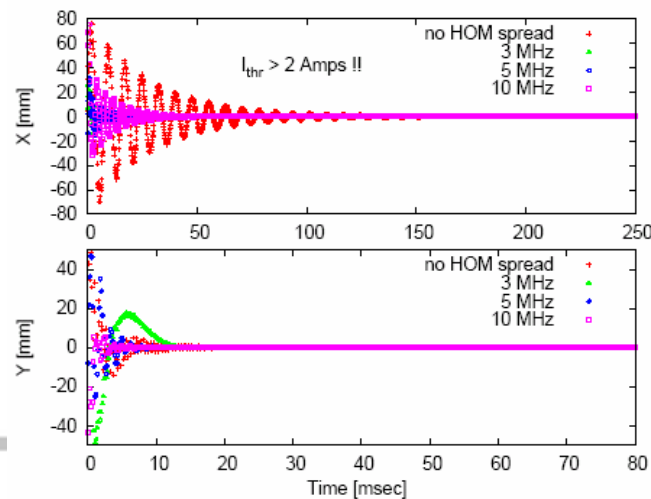

Courtesy of I. Ben-Zvi



# JLab Ampere-class Cavity

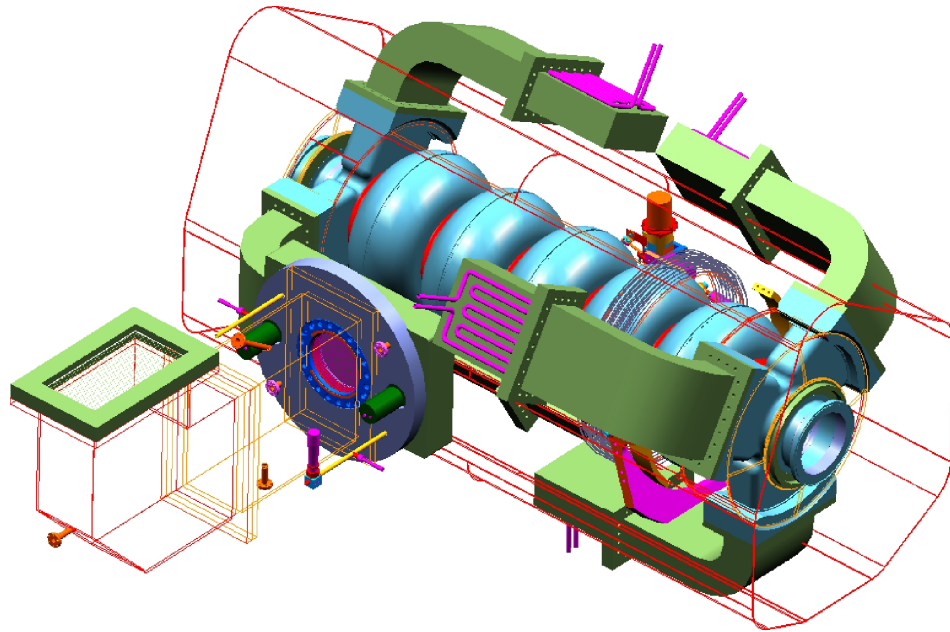

Cryomodule concept

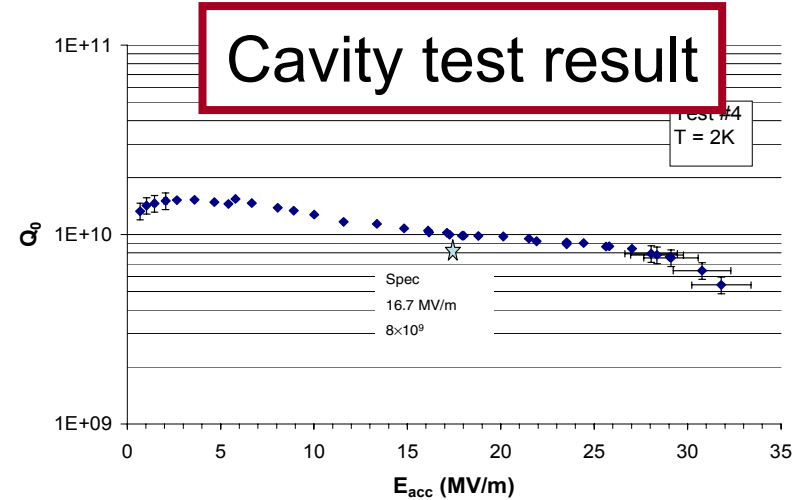

1500 MHz Cu prototype

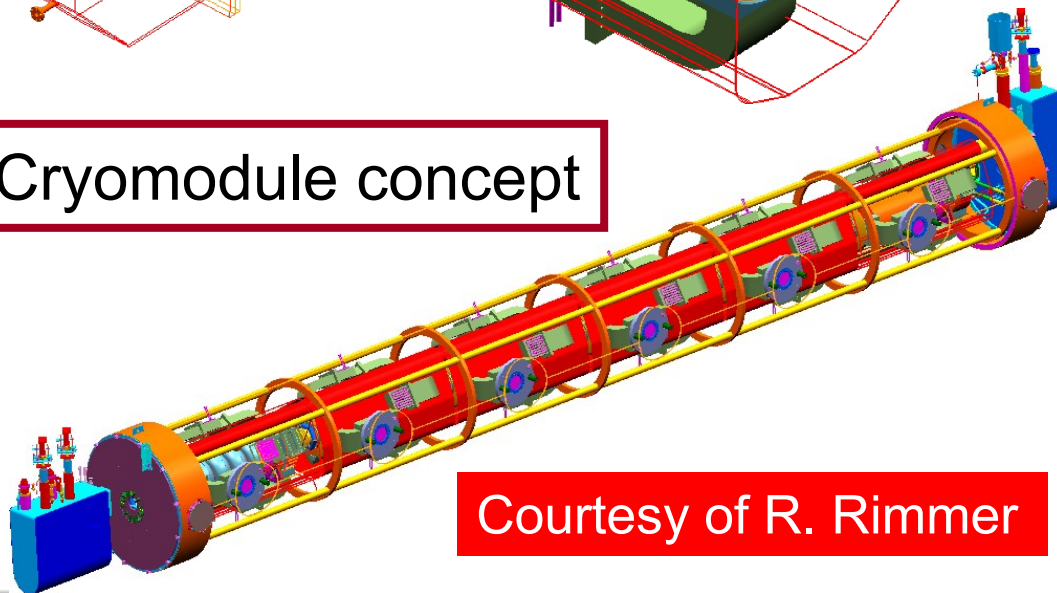

Courtesy of R. Rimmer

# RF Control in ERLs

---

- **Accelerating and decelerating beam phases may not differ by precisely  $180^\circ$** 
  - **Typical expected path length control adjustment leads to  $\sim 0.5^\circ$  deviation from  $180^\circ$**

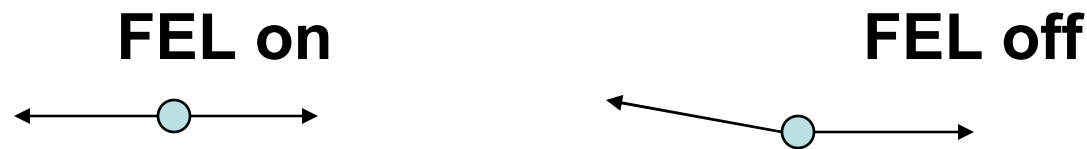

- **Beam loss may occur, resulting in beam vectors of unequal magnitude**
- **All of the above give rise to a net beam loading vector, typically of reactive nature in the case of phase errors**
- **Increase of rf power requirements and reduction of efficiency**